

2024-25

Commercial Furniture Catalogue



Convenient
Commercial Furniture

www.convenientinteriors.com.au

info@convenientinteriors.com.au

Unit 20 / 19 Warehouse Road, Southport

1300 728 874

Welcome

Welcome to our 2024 - 2025 Product Catalogue!

Discover elegance, functionality, and craftsmanship at its finest with our exclusive range of commercial furniture solutions. Whether you're furnishing a cozy café, a bustling restaurant or a sleek office space we have curated designs to meet all the commercial grade specifications. From timeless classics like the Albury range to modern innovations being released throughout the year, each piece is manufactured and sourced with precision and designed with commercial durability in mind.

We pride ourselves on offering tailored services to enhance your product selections and elevate their uniqueness. Our custom upholstery and precision powder coating services ensure each piece meets your exact specifications, while our assembly service simplifies your workflow.

In addition to our bespoke services, we provide comprehensive digital resources for every product in our catalogue. From technical data sheets to detailed assembly instructions and videos, as well as care and maintenance manuals and product finish booklets, we equip you with everything you need to confidently buy and sell our products.



Indoor Collection

1



Upholstered Chairs and Stools

Albury Side Chair and Stool

Albury Arm Chair and Stool

Albury XL Chair

Bronte Chair

Hugo Chair

Coogee Chair

Stockholm Chair and Stool

Chevron Chair and Stool

Welcome to our exclusive collection of commercial-grade upholstered chairs and stools, designed to elevate any setting with style and durability. Featuring a diverse array of shapes and styles, our collection includes the Albury, Chevron, Stockholm, Bronte, Hugo, and Coogee models.

Crafted in China and backed by a 12-month warranty, each piece is upholstered with premium Warwick fabric ranges including Pelle, Benito, Gravity, Eastwood and Regis, as well as Ez Vinyl for exceptional comfort and longevity.

Available with versatile base options such as metal 4-leg, timber 4-leg, and office bases, our collection offers the perfect seating solution for any commercial space. All available to be custom upholstered if required.



Albury Side

The Albury side chair and stool was designed for comfort and style. Also available in an arm and XL version, the Albury Side is perfect for various seating needs.

Available in a 4 leg metal or timber base as well as a range of office frames it is ideal for commercial office or hospitality spaces. The Albury side can be custom upholstered but comes standard in multiple Warwick Fabric ranges including Pelle/Benito, Gravity and Eastwood along with Ez vinyl. The Albury combines sleek design with practical functionality, making it a standout choice for any environment.

Shell fabrics and colours



Metal line



The model presented features Birch leg frames from mild steel, Gravity shell fabric, the Denim colour

Metal line - H650 Stool



The model presented features Black leg frames from mild steel, Vinyl shell fabric, the Blue colour

Metal line - H750 Stool

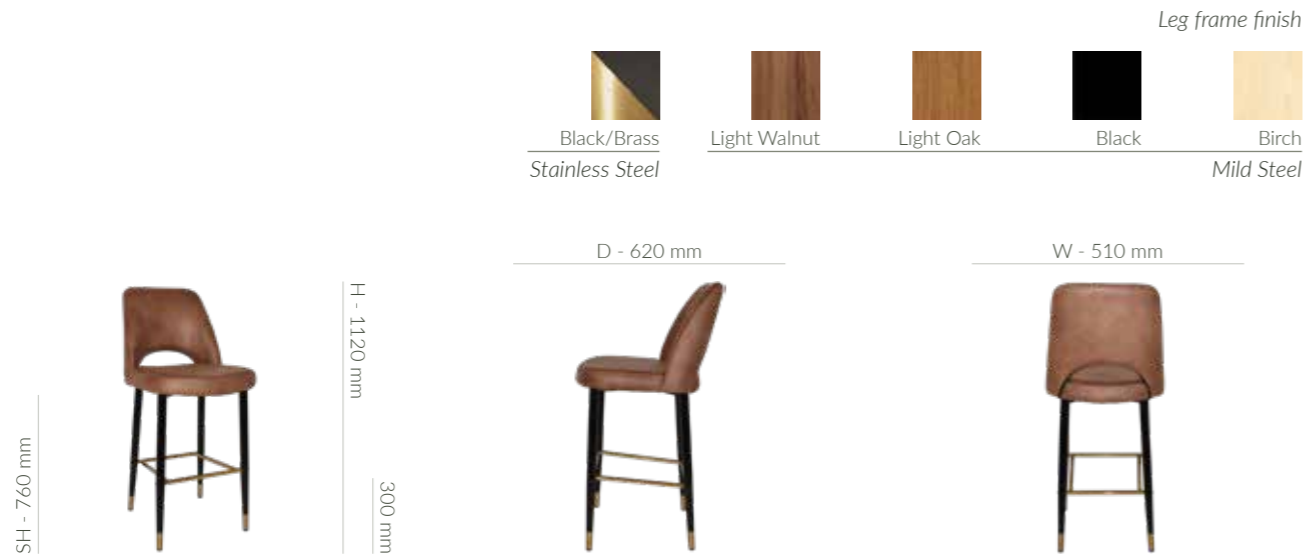

The model presented features Black Brass leg frames from stainless steel, Eastwood shell fabric, the Tan colour

Albury Side

Timber line



The model presented features Light Walnut leg frames from solid ash, Pelle Benito shell fabric, the Tan colour

Office line

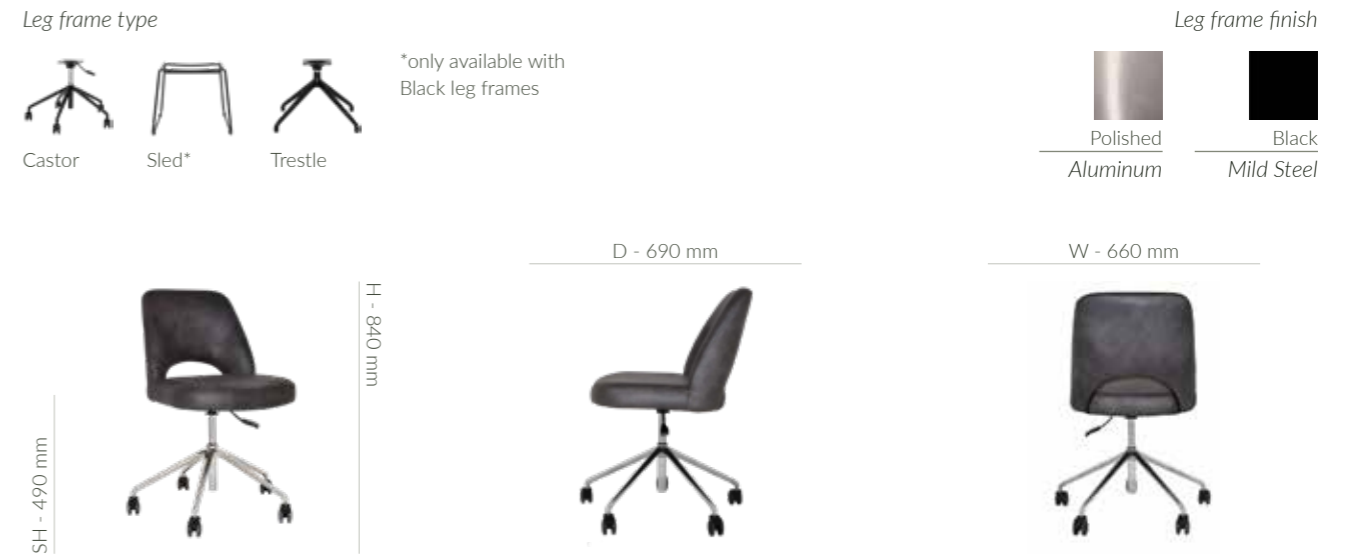

The model presented features Castor leg frames from polished aluminum, Eastwood shell fabric, the Slate colour

Albury Side



The model presented features Black Sled leg frames from mild steel, Vinyl shell fabric, the Blue colour



The model presented features Black Trestle leg frames from mild steel, Gravity shell fabric, the Steel colour

Albury Arm

Discover the versatility and style of the Albury Arm, featuring chairs and stools crafted for superior comfort. This collection also includes side chairs and stools along with an XL chair, ensuring a perfect fit for any seating configurations.

Available in a 4 leg metal or timber base as well as a range of office frames it is ideal for commercial office or hospitality spaces. The Albury Arm can be custom upholstered but comes standard in multiple Warwick Fabric ranges including Pelle/Benito, Gravity and Eastwood along with Ez vinyl. The Albury armchair showcases a classic design and practical functionality, making it a standout choice for any setting.



Shell fabrics and colours

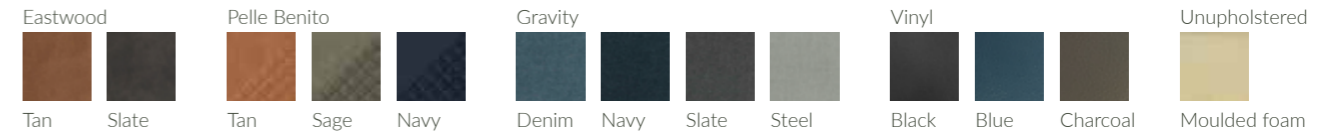

Metal line

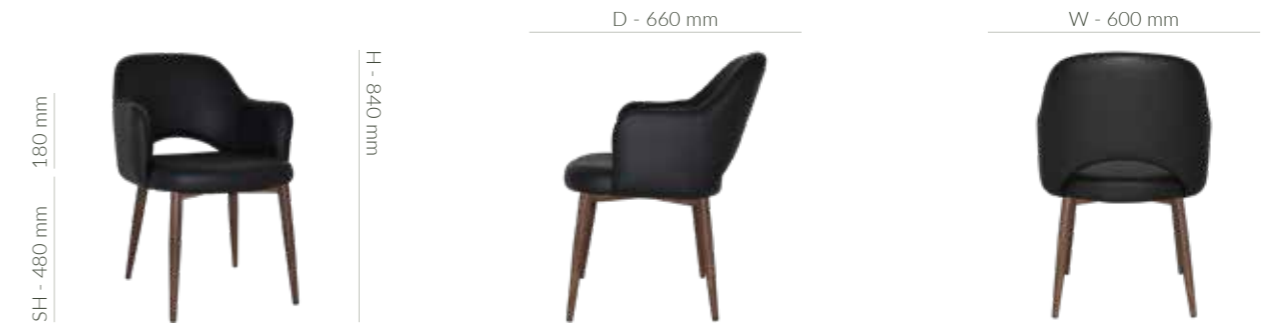

The model presented features Light Walnut leg frames from mild steel, Vinyl shell fabric, the Black colour

Timber line



The model presented features Natural leg frames from solid ash, Eastwood shell fabric, the Slate colour

Albury Arm

Metal line - H650 Stool



The model presented features Birch leg frames from mild steel, Pelle Benito shell fabric, the Sage colour

Metal line - H750 Stool

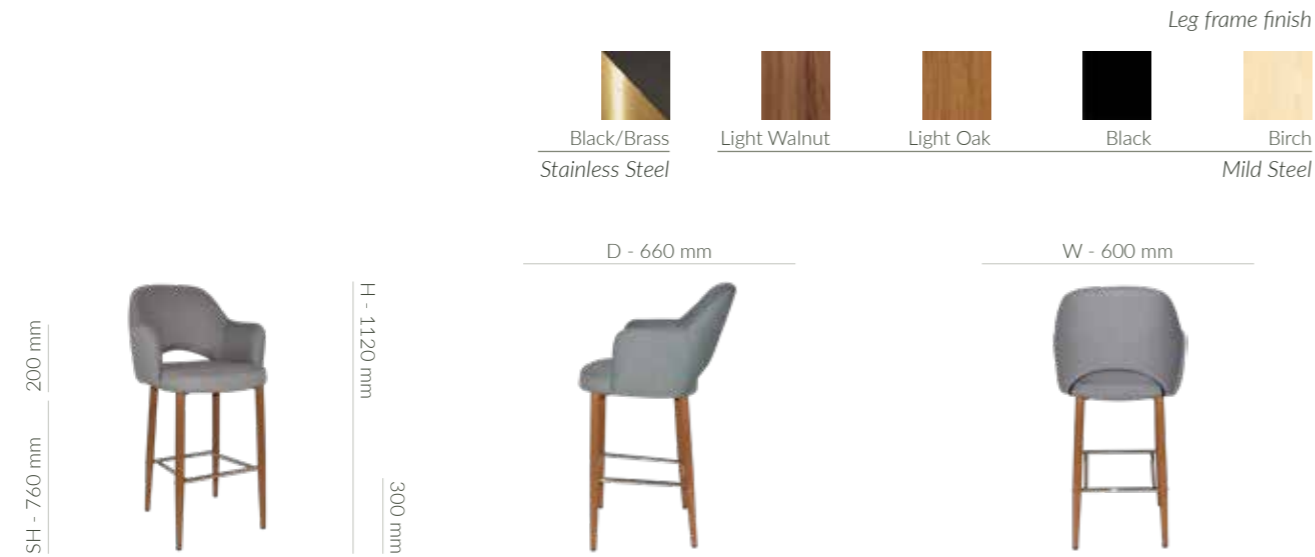

The model presented features Light Oak leg frames from solid ash, Gravity shell fabric, the Steel colour

Albury Arm

Office line



The model presented features Castor leg frames from mild steel in Black, Pelle Benito shell fabric, the Sage colour

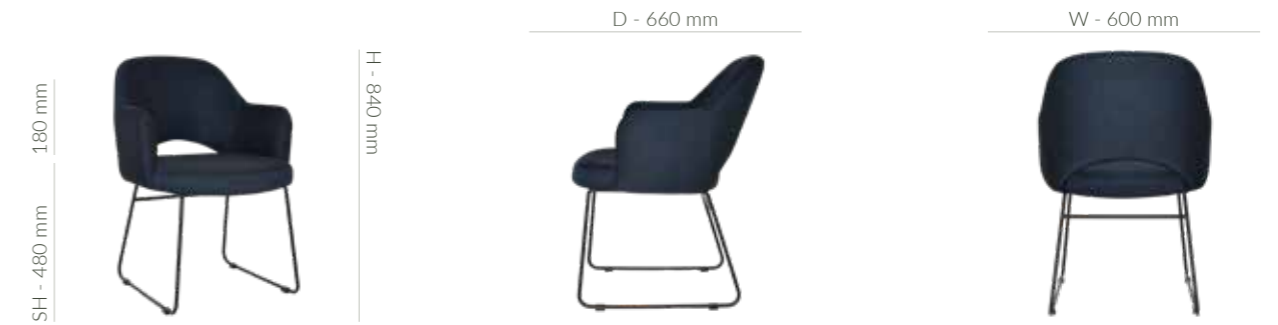

The model presented features Black Sled leg frames from mild steel, Gravity shell fabric, the Navy colour



The model presented features Trestle leg frames from polished aluminum, Vinyl shell fabric, the Charcoal colour

Albury Arm

Albury XL

The Albury XL Chair complements the Albury Side and Arm range, offering a larger seat footprint for spaces that require more room, adding to the array of seating arrangements.

Available in a variety of metal or timber 4 leg frames, it can be custom upholstered but comes standard in multiple Warwick Fabric ranges including Pelle/Benito, Gravity and Eastwood along with Ez vinyl. This chair is a versatile addition to any commercial setting, ensuring durability and elegance in any space.

Shell fabrics and colours



Timber line

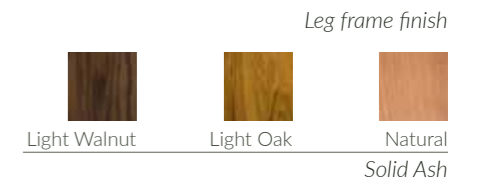

The model presented features Natural leg frames from solid ash, Vinyl shell fabric, the Blue colour

Metal line



The model presented features Light Oak leg frames from mild steel, Gravity shell fabric, the Navy colour

Bronte

Introducing our tub-style chair the Bronte, perfect for office, aged care, and hospitality environments. Designed for comfort and elegance, this chair features a sleek, curved silhouette that adds a touch of sophistication to any space.

Available with metal or timber 4-leg frames as well as a sled-style base, the Bronte offers flexible options to match your décor and functional needs. Upholstered in Warwick Fabrics Pelle or Gravity with the addition of Ez vinyl as well as the ability to be custom upholstered, it's robust construction ensures durability, while the ergonomic design provides superior comfort for extended seating.

Shell fabrics and colours



Metal line



The model presented features Birch leg frames from mild steel, Pelle shell fabric, the Sage colour

Office line

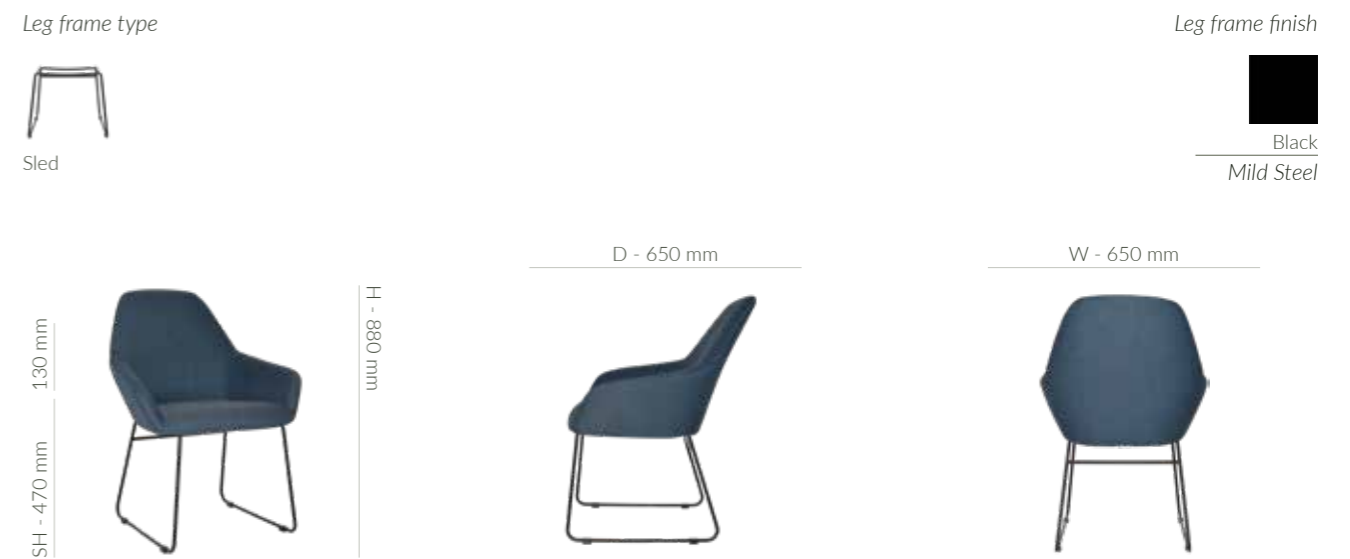

The model presented features Black Sled leg frames from mild steel, Gravity shell fabric, the Denim colour

Timber line



The model presented features Light Oak leg frames from solid ash, Gravity shell fabric, the Steel colour

Hugo

Introducing our Hugo Armchair, a perfect blend of bold design and ultimate comfort. Upholstered in luxurious Warwick fabrics Pelle and durable Ez Vinyl, this armchair is a stylish addition to any space.

Choose from a sturdy metal or timber 4-leg frame, or opt for the lounge-style sled base for a modern touch. The Hugo Armchair offers both aesthetic appeal and robust construction, making it an ideal choice for various environments.

Shell fabrics and colours



Bronte



Metal line



The model presented features Black leg frames from mild steel, Pelle shell fabric, the Tan colour

Timber line

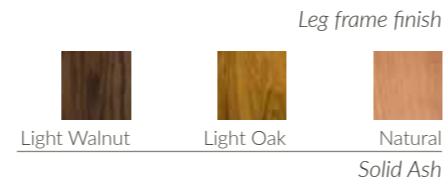

The model presented features Walnut leg frames from solid ash, Vinyl shell fabric, the Black colour

Hugo

Office line

Leg frame type



Cross Sled

Leg frame finish



The model presented features Black Cross Sled frames from mild steel, Pelle shell fabric, the Navy colour

Coogee

Discover the elegant Coogee, designed to enhance any setting with its sophisticated style. Upholstered in premium Warwick fabrics Gravity, this chair offers both luxury and longevity.

Featuring ribbed back stitching for a touch of refined detail, it is available with a choice of metal or timber 4-leg frames, as well as a variety of office-style bases. This versatile armchair seamlessly combines comfort, durability, and elegance, making it an ideal addition to any office, lounge, or reception area.

Shell fabrics and colours

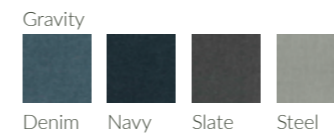

Metal line



The model presented features Light Oak leg frames from mild steel, Gravity shell fabric, the Slate colour

Timber line

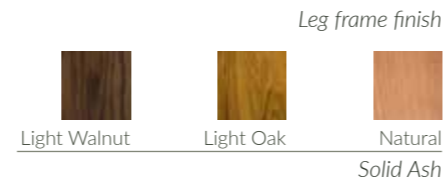

The model presented features Natural leg frames from solid ash, Gravity shell fabric, the Navy colour

Office line

Leg frame type



*only available with Black leg frames

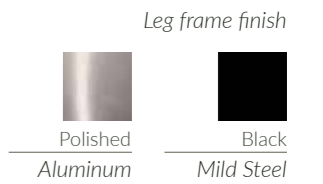

The model presented features Castor leg frames from polished aluminum, Gravity shell fabric, the Steel colour



The model presented features Black Sled leg frames from mild steel, Gravity shell fabric, the Denim colour



The model presented features Black Trestle leg frames from mild steel, Gravity shell fabric, the Slate colour

Stockholm

The Stockholm chair and stool, a perfect blend of contemporary design and comfort. Upholstered in luxurious Warwick fabrics Pelle or custom fabric, this chair features a striking angular silhouette that adds a modern touch to any space.

Available with a choice of sturdy metal or timber 4-leg bases, as well as multiple office-style frames, the Stockholm chair offers versatile options to suit your specific needs.

Shell fabrics and colours



Metal line



The model presented features Brushed Brass leg frames from stainless steel, Pelle shell fabric, the Tan colour

Metal line - H650 Stool

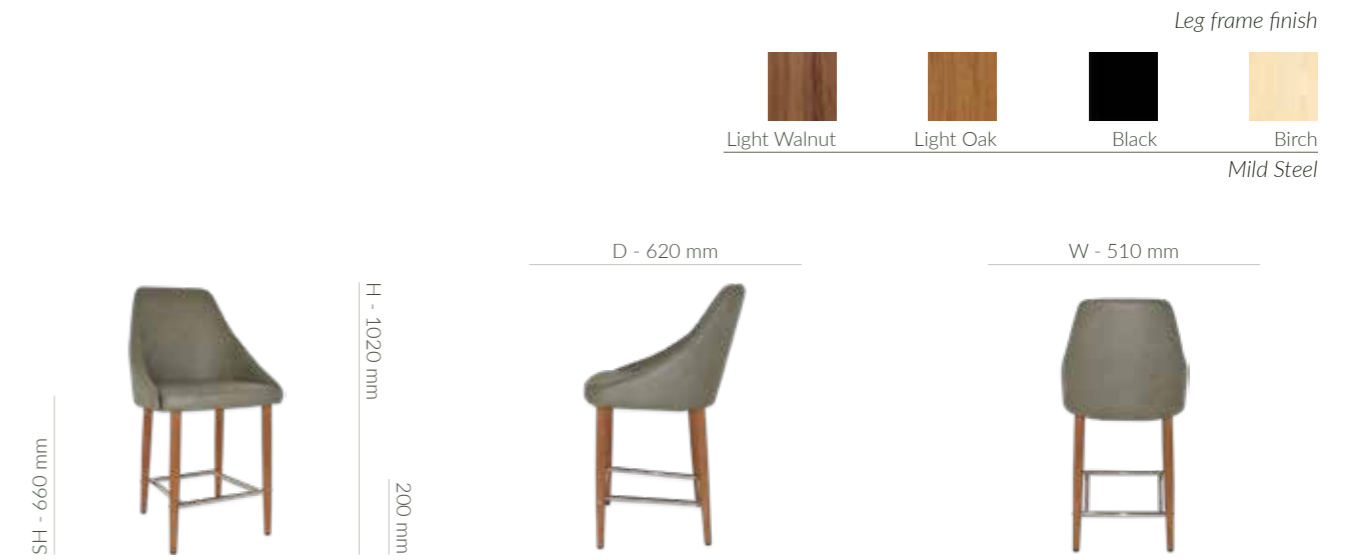

The model presented features Light Oak frames from solid ash, Pelle shell fabric, the Sage colour

Metal line - H750 Stool



The model presented features Black leg frames from mild steel, Pelle shell fabric, the Navy colour

Timber line



The model presented features Light Oak leg frames from solid ash, Pelle shell fabric, the Sage colour

Metal line



The model presented features Birch leg frames from mild steel, Regis shell fabric, the Navy colour

Chevron

Our Chevron is an elegant side chair and stool, a perfect fusion of sophistication and comfort. Available custom upholstered or in premium Warwick fabrics Regis, these pieces bring a touch of class to any setting.

Choose from a multitude of 4-leg metal or timber frames, or opt for office-style bases to suit your specific needs. With its graceful, rounded design and versatile frame options, this side chair and stool set is ideal for offices, lounges, and reception areas, offering both style and durability.

Shell fabrics and colours

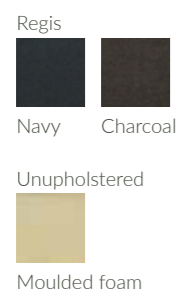

Metal line - H750 Stool

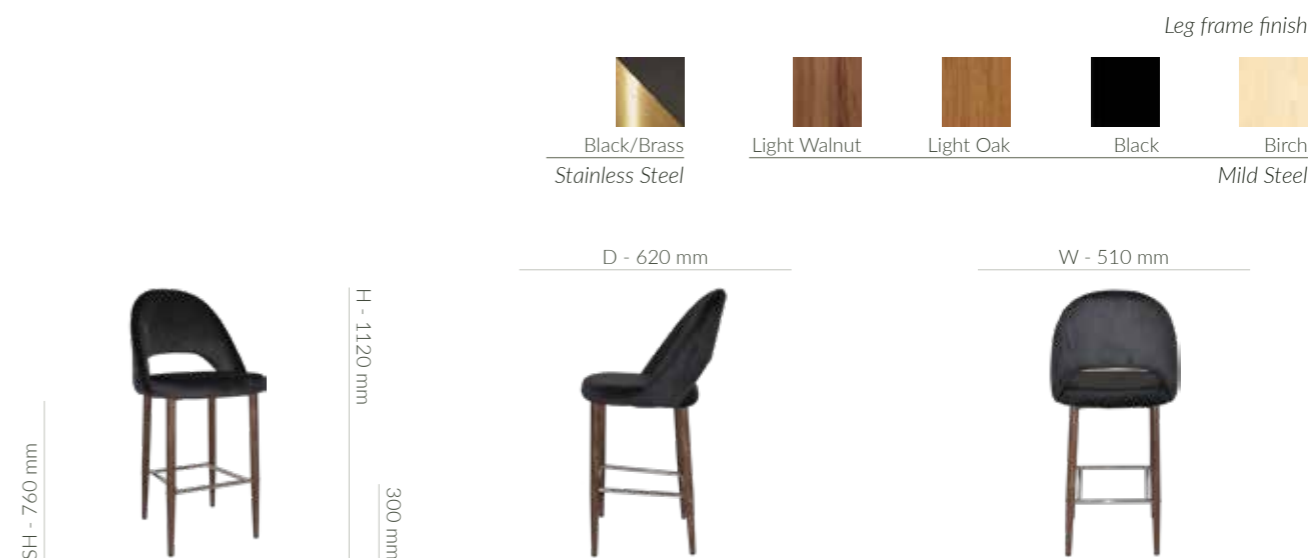

The model presented features Light Walnut leg frames from mild steel, Regis shell fabric, the Charcoal colour

Timber line

Leg frame finish

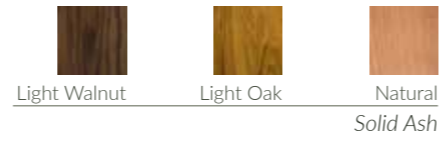

The model presented features Light Walnut leg frames from solid ash, Regis shell fabric, the Charcoal colour

Office line

Leg frame type



Sled

Leg frame finish



Black
Mild Steel



The model presented features Black Sled leg frames from mild steel, Regis shell fabric, the Navy colour

Princess Side chairs



Chevron

Dining Chairs and Stools

Phoenix Chair and Stool

Rialto Chair and Stool

Torino Chair and Stool

Princess Side Chair and Stool

Texas Chair and Stool

Marco Chair and Stool

Lugano Chair and Stool

Kansas Chair and Stool

Sedona Stool

Arizona Stool

Bonn Stool

Fuji Stool

Tokyo Stool

Lima Stool

Oslo Stool

Dublin Stool

London Stool

Delhi Ottoman

Welcome to our diverse collection of timber and metal dining chairs and stools, meticulously crafted to elevate both hospitality dining environments and office settings. Embracing a broad spectrum of shapes and styles, our collection ensures there's a perfect match for every aesthetic preference.

Each chair and stool is designed to cater to your comfort and style preferences. Customise with upholstered pads tailored to your specifications, or opt for our stock line available in luxurious Ez vinyl or Warwick Fabrics Pelle. Explore a spectrum of stain finishes, including the timeless elegance of light oak, the warmth of natural hues, the richness of walnut, or the contemporary appeal of black.

Phoenix

The Phoenix Chair and Stool Range, crafted with a solid ash frame with backs and seats in timber veneer, this collection offers a blend of durability and aesthetic appeal.

Each piece in the Phoenix is available in a variety of finishes, including light oak, natural, walnut, or black stains. Opt for black vinyl upholstery for a sleek, modern finish, or customize with your choice of upholstery to suit your décor.

The rounded square-shaped back design enhances comfort and style, making the Phoenix range suitable for both dining and office environments.



Back & seat fabrics and colours

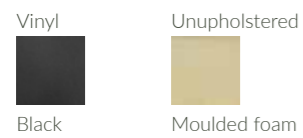

Back and seat timber finish - American Oak Veneer

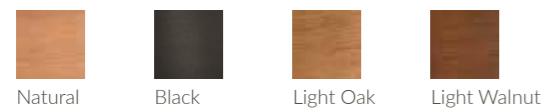

Upholstered back & seat line

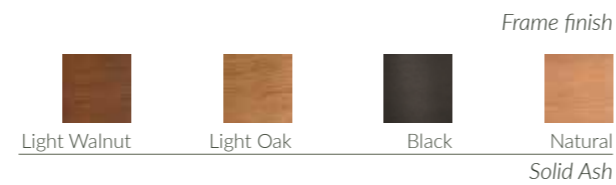

The model presented features the Natural frame from American oak, Vinyl back and seat fabric, the Black colour

Upholstered seat line

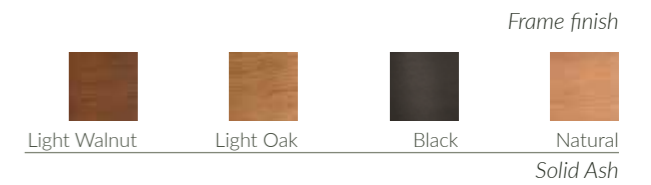

The model presented features the Light Oak frame from American oak, Unupholstered seat fabric

Veneer line

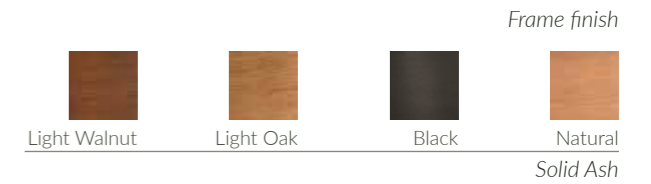

The model presented features the Light Walnut frame from American oak

Stool - H750-770

Available in three versions: upholstered back & seat, upholstered seat and veneer

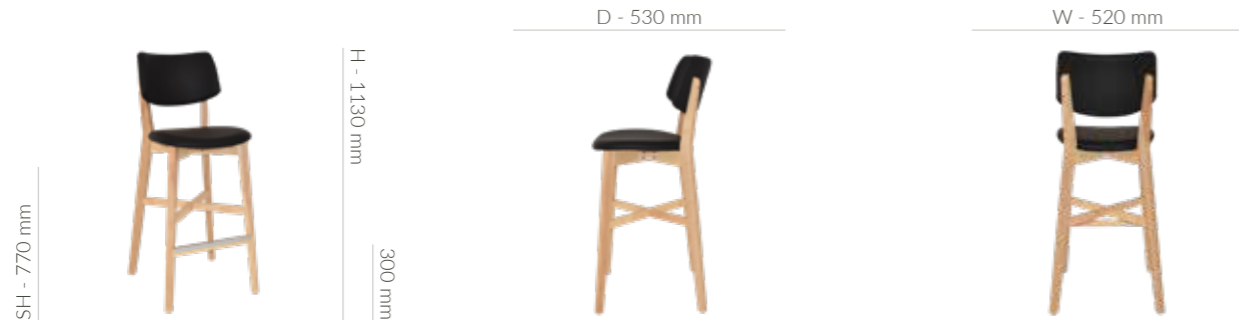
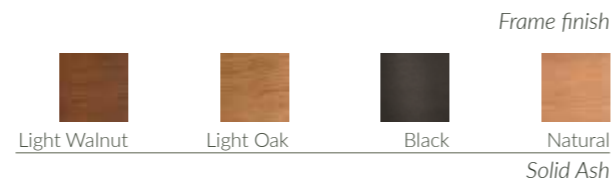

The model presented is the Upholstered seat & back line, featured in the Natural frame from American oak, Vinyl back and seat fabric, the Black colour. The Veneer line has a SH of 750 mm

Rialto

The Rialto chair and stool range, where classic design meets modern elegance. Crafted with a solid ash frame with backs, and seats in timber veneer, this collection epitomises durability and sophistication.

Available in a variety of finishes, including light oak, natural, walnut, or black stains, each piece seamlessly blends with any decor. Choose between sleek black vinyl upholstery for a contemporary look or customize with your preferred fabric to personalize your space.

The distinctive half-moon shaped back enhances comfort and adds a touch of style, making the Rialto range ideal for dining spaces and office settings.

Back & seat fabrics and colours

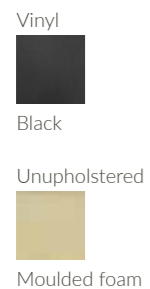

Back and seat timber finish - American Oak Veneer

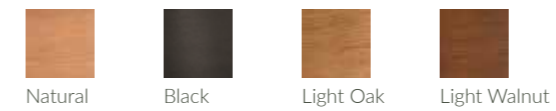

Upholstered back & seat line

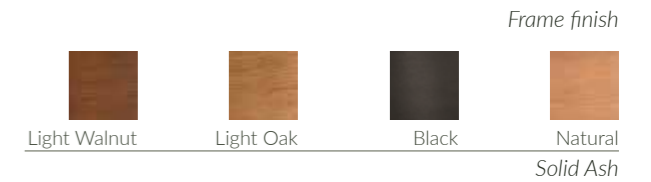

The model presented features the Light Oak frame from solid ash, back and seat from American oak veneer, Unupholstered back and seat fabric

Upholstered seat line

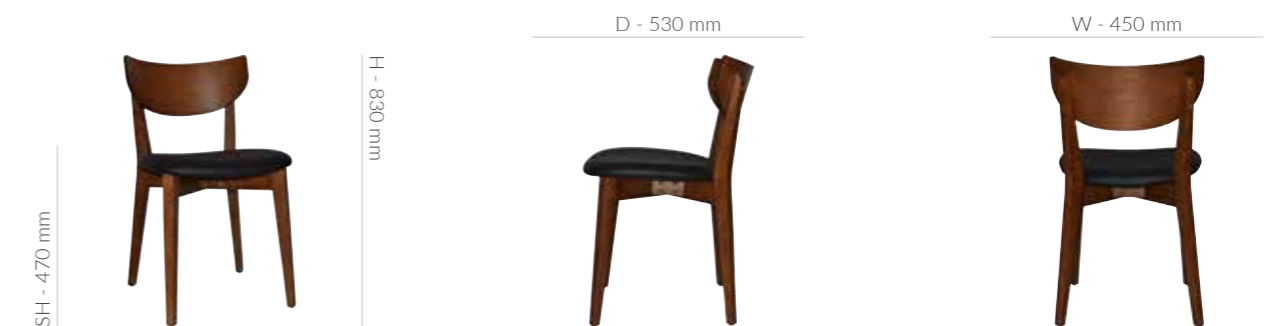
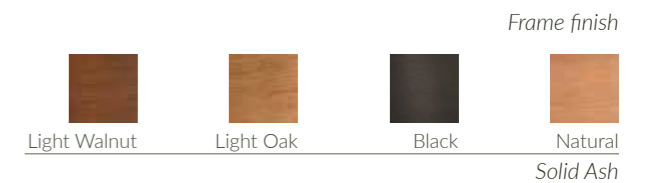

The model presented features the Light Walnut frame from solid ash, back from American oak veneer, Vinyl seat fabric, the Black colour

Veneer line



The model presented features the Natural frame from solid ash; back and seat from American oak veneer

Stool - H750-770

Available in three versions: upholstered back & seat, upholstered seat and veneer



The model presented is the Upholstered seat & back line, featured in a Black frame from solid ash, Vinyl back and seat fabric, the Black colour. The Veneer line has a SH of 750 mm

Torino

The Torino chair and stool range, crafted with a solid ash frame available in light oak, natural, walnut, or black stains.

Customize your comfort by choosing between Ez Black vinyl seat and back pads for a sleek, contemporary appearance, or opt for custom upholstery in your preferred fabric to complement your decor perfectly.

The rounded rectangular shaped back enhances both comfort and modern style, making the Torino range a versatile choice for dining areas and office environments alike.

Back & seat fabrics and colours

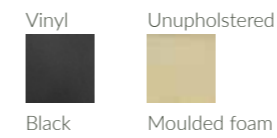

Upholstered back & seat line



The model presented features the Natural frame from solid ash, back and seat from American oak veneer, Vinyl back and seat fabric, the Black colour

Rialto

Stool - H750-770

Available in three versions: upholstered back & seat, upholstered seat and veneer

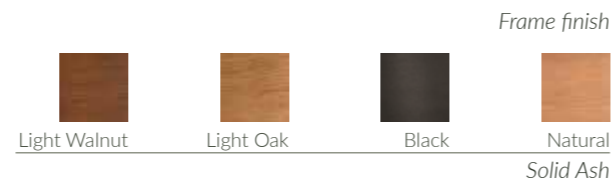

The model presented features the Light Oak frame from solid ash, back and seat from American oak veneer, Unupholstered back and seat fabric. The Veneer line has a SH of 750 mm

Upholstered seat line

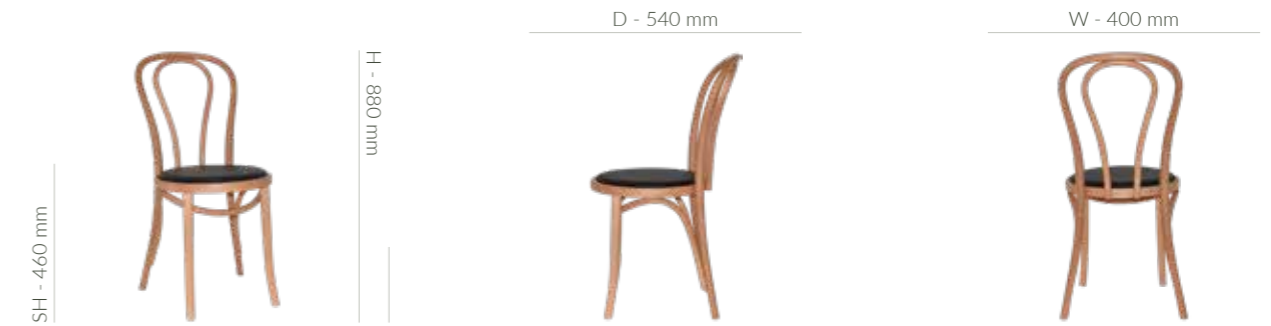
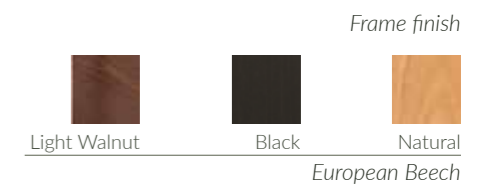

The model presented features the Natural frame from European beech, Vinyl seat fabric, the colour Black

Princess Side

Our European beech bentwood chair and stool range the Princess, meticulously handmade in Poland. Available in natural, walnut, or black timber finishes, each piece embodies timeless elegance and durability.

Customise your seating experience and enhance comfort with the option to add a sleek black vinyl seat pad for a modern touch, or personalise with a custom seat pad in your preferred fabric to match your decor..

Ideal for both commercial and residential settings, the Princess chair and stool combines classic design with versatility, promising enduring quality and aesthetic appeal.

Seat fabrics and colours

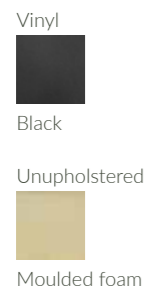

Veneer line

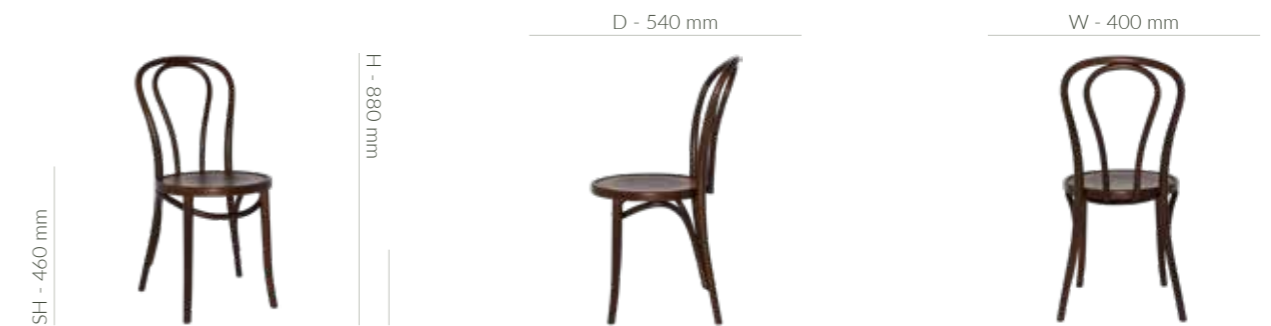
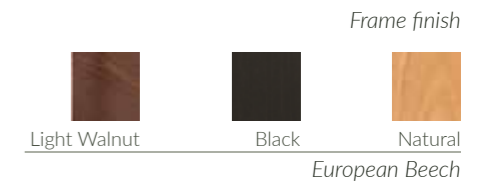

The model presented features the Light Walnut frame from European beech

Princess Side

Stool - H750-770

Available in two versions: upholstered seat and veneer

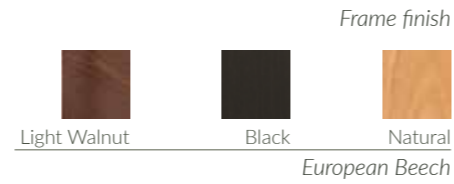

The model presented features the Veneer line, Light Walnut frame made from European beech, Vinyl seat fabric, the colour Black. The Upholstered line has a SH of 770 mm

Texas

The Texas metal frame dining chair and stool, blends modern design with versatility. Crafted with a sturdy mild or stainless steel frame in black or brass finishes, these pieces elevate any dining area.

Choose from timber veneer seats and backs in light oak, natural, walnut, and black stains for a sophisticated look or customise your comfort with black vinyl upholstery or custom options.

The rounded square back shape enhances comfort and modern elegance. Ideal for residential and commercial settings, our Texas chair and stool promise durability and style.

Back & seat fabrics and colours

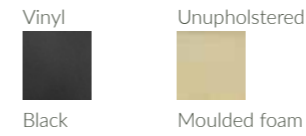

Back and seat timber finish - American Oak Veneer

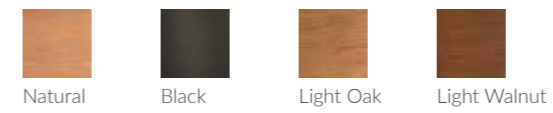

Upholstered back & seat line

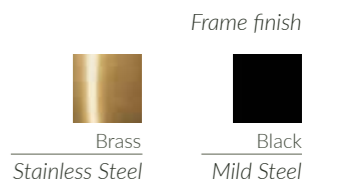

The model presented features the Black frame from mild steel steel, Vinyl back and seat fabric, the Black colour

Princess Side

Upholstered seat line



The model presented features the Brass frame from stainless steel, back made from timber veneer, Natural finish, Vinyl seat fabric, the colour Black

Veneer line

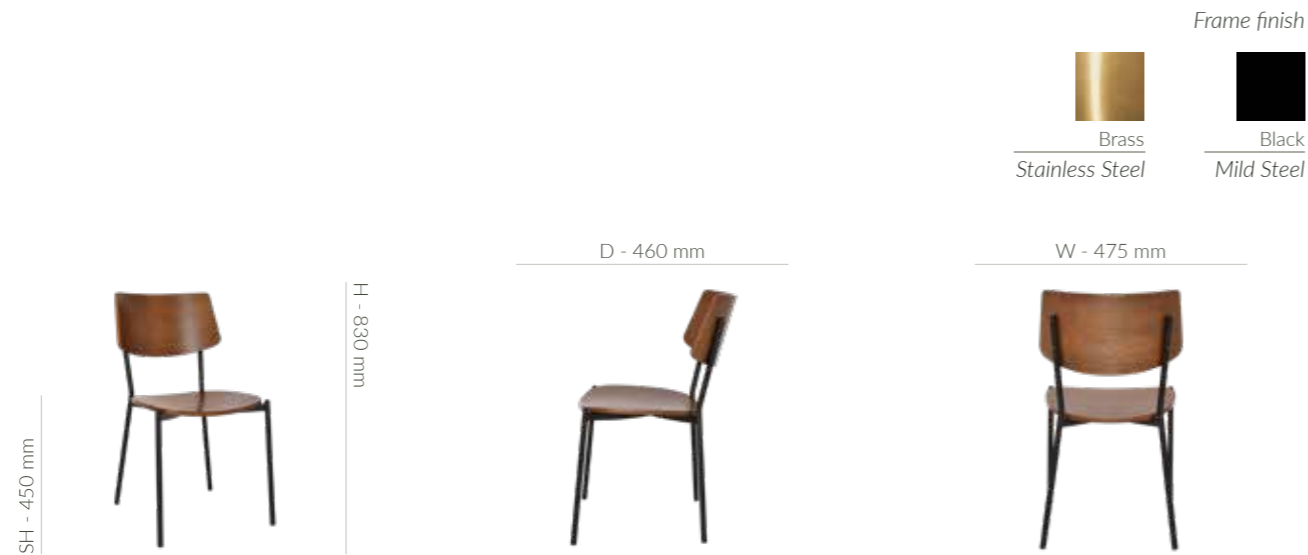

The model presented features the Black frame from mild steel, Light Walnut back and seat made from timber veneer

Texas

Stool - H750-770

Available in three versions: upholstered back & seat, upholstered seat and veneer



The model presented is the Veneer line, featured in the Brass frame from stainless steel, Black back and seat from timber veneer
The Upholstered version has a 770 mm SH

Marco

The Marco, a mild or stainless steel dining chair and stool crafted for comfort and style. Available in black or brass finishes, these pieces elevate any dining area with sleek metal frames.

Featuring timber veneer seats and backs in light oak, natural, walnut, and black stains, offering versatile design options. Customise your seating with choices including black vinyl upholstery or custom options.

The curved half-moon back enhances comfort and adds contemporary flair to your space. Ideal for residential and commercial settings, the Marco chair and stool promise durability and sophistication.

Back & seat fabrics and colours

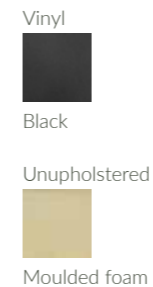

Back and seat timber finish - American Oak Veneer

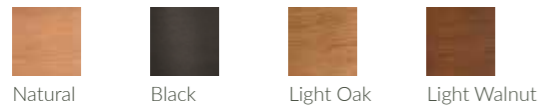

Upholstered back & seat line

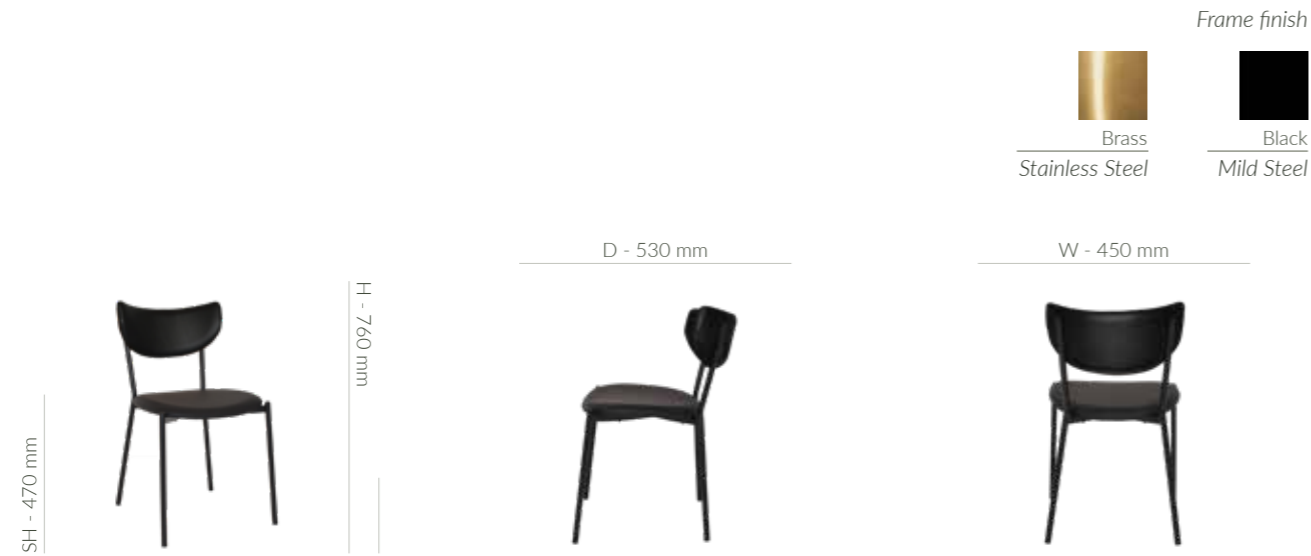

The model presented features the Black frame from mild steel, back and seat from timber veneer, Vinyl back and seat fabric, the colour Black

Upholstered seat line

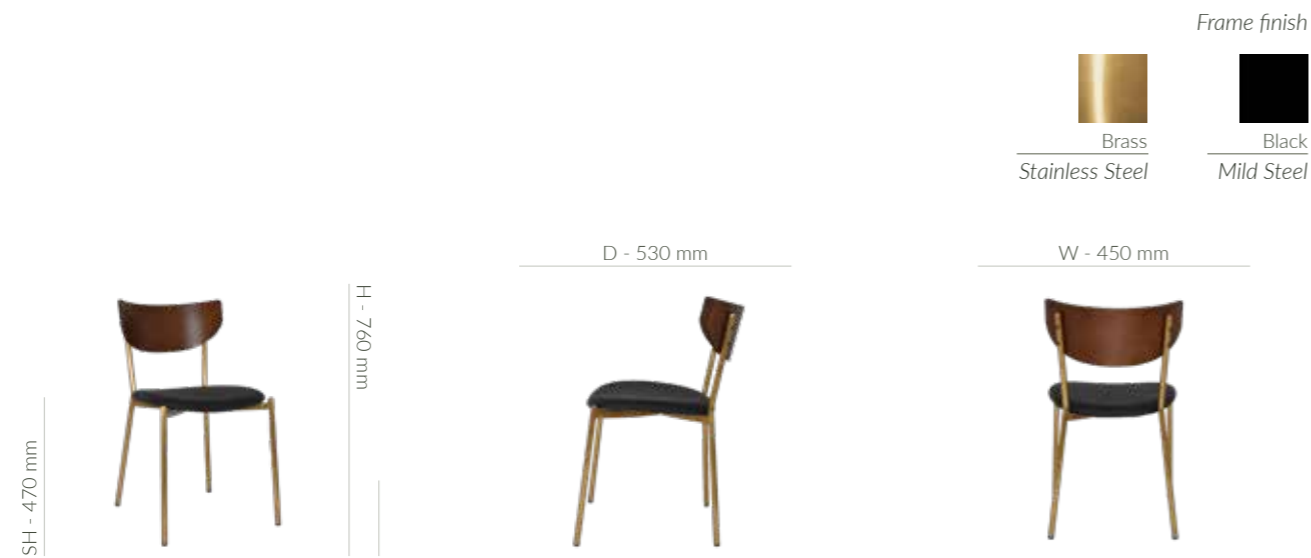

The model presented features the Brass frame from stainless steel, back from timber veneer, Light Walnut finish, Vinyl seat fabric, the colour Black

Veneer line

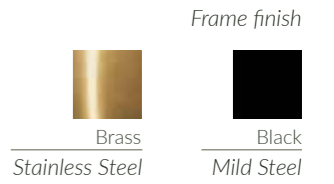

The model presented features the Brass frame from stainless steel, Light Oak back and seat made from timber veneer

Stool - H750-770

Available in three versions: upholstered back & seat, upholstered seat and veneer

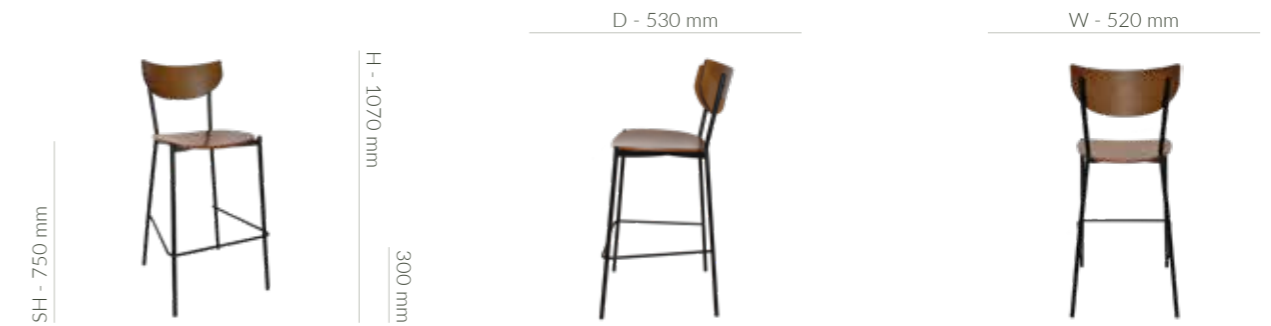
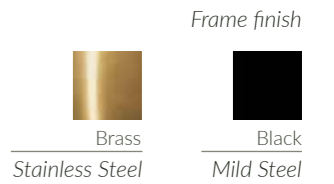

The model presented is the Veneer line, featured in the Black frame from mild steel, the Light Walnut back and seat made from timber veneer. The Upholstered version has a 770 mm SH



Lugano

The Lugano mild or stainless steel dining chair and stool, crafted for contemporary elegance and comfort. Available in black or brass finishes, these chairs and stools elevate any dining area with their sleek metal frames.

Featuring vinyl black or custom upholstered back and seat options, you can personalise your comfort and style to suit your space perfectly. The rounded rectangle back shape enhances both support and modern aesthetic.

Ideal for residential and commercial settings, the Lugano combine durability with sophisticated design, promising enduring appeal in any space.

Back & seat fabrics and colours

- Vinyl 
- Black
- Unupholstered 
- Moulded foam



Upholstered back & seat line







Frame finish

 Brass
 Stainless Steel

 Black
 Mild Steel

The model presented features the Black frame from mild steel, Vinyl back and seat fabric, the Black colour

Stool - H770

Available in one version: upholstered back & seat







Frame finish

 Brass
 Stainless Steel

 Black
 Mild Steel

The model presented is featured in the Black frame from mild steel, Vinyl back and seat, colour Black

Kansas

The Kansas, crafted with a sleek metal frame in mild or stainless steel options, these chairs and stools elevate any dining area with contemporary style.

Customise with rib-stitched back and seat upholstery options in Warwick Fabrics Pelle, Ez Vinyl, or your preferred fabric for personalised comfort. The rounded square back shape provides ample support and enhances the sophistication of your space.

Ideal for residential and commercial settings, our black or brass dining chairs and stools offer durability and timeless elegance.

Back & seat fabrics and colours

- Vinyl 
- Black
- Forest 
- Eastwood 
- Tan
- Pelle 
- Sage
- Unupholstered 
- Moulded foam



Upholstered back & seat line



The model presented features the Brass frame from stainless steel, Eastwood back and seat fabric, the colour Tan

Stool - H770

Available in one version: upholstered back & seat



The model presented is featured in the Black frame from mild steel, Vinyl back and seat fabric, the Black colour

Stools

Discover our diverse range of stools featuring both timber and metal frames, providing versatile seating solutions for any environment.

Choose between timber seats for a classic aesthetic or upholstered pads in various fabrics to enhance comfort and style.

Our stools combine durability with aesthetic appeal, making them ideal for a variety of residential and commercial settings.

Back & seat fabrics and colours

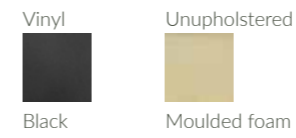

Vinyl - only for Dublin, Fujii, Lima, London, Tokyo, Oslo



Upholstered Bonn stool

Sedona



The model presented features the Natural frame from American ash, Vinyl seat fabric, the Black colour

Kansas

Arizona

Available in two versions: upholstered seat and veneer

Frame finish



Natural
American Ash



The model presented is the Veneer line, featured in the Natural frame from American ash and Natural seat from American oak veneer

Bonn

Available in two versions: upholstered seat and veneer

Frame finish



Light Walnut



Light Oak



Natural
Rubberwood



The model presented features the Light Oak frame from rubberwood, Vinyl seat fabric, the Black colour

Fuji

Frame finish



Polished
Stainless Steel



The model presented is featured in the polished stainless steel frame, Vinyl back and seat, colour Charcoal

Tokyo

Frame finish



Polished
Stainless Steel



The model presented features the polished stainless steel frame, Vinyl seat fabric in two colours: White or Black

Lima

Frame finish



Polished
Stainless Steel



The model presented is featured in the polished stainless steel frame, Vinyl back and seat fabric, the Blue colour

Oslo

Frame finish



Polished
Stainless Steel



The model presented features the polished stainless steel frame, Vinyl seat fabric in two colours: White and Charcoal

Dublin

Frame finish



Black
Mild Steel



The model presented is featured in the Black frame made from mild steel, Vinyl back and seat, colour White

London

Frame finish



Black
Mild Steel



The model presented features the Black frame from mild steel, Vinyl seat fabric in two colours: Black and Blue



Delhi

Experience modern elegance with our Delhi range available in a round ottoman or matching bench set, both upholstered in sleek black vinyl.

Perfect for enhancing any room, choose this set to elevate your lounge or learning space with uniform upholstery that combines comfort and style.

Ideal for education or hospitality commercial settings, this duo promises to add contemporary sophistication to your decor.

Shell fabrics and colours

Vinyl	Unupholstered
	
Black	Moulded foam



Ottomans



The model presented features the Vinyl seat fabric, the Black colour

Benches



The model presented features the Vinyl seat fabric, the Black colour

Square table base

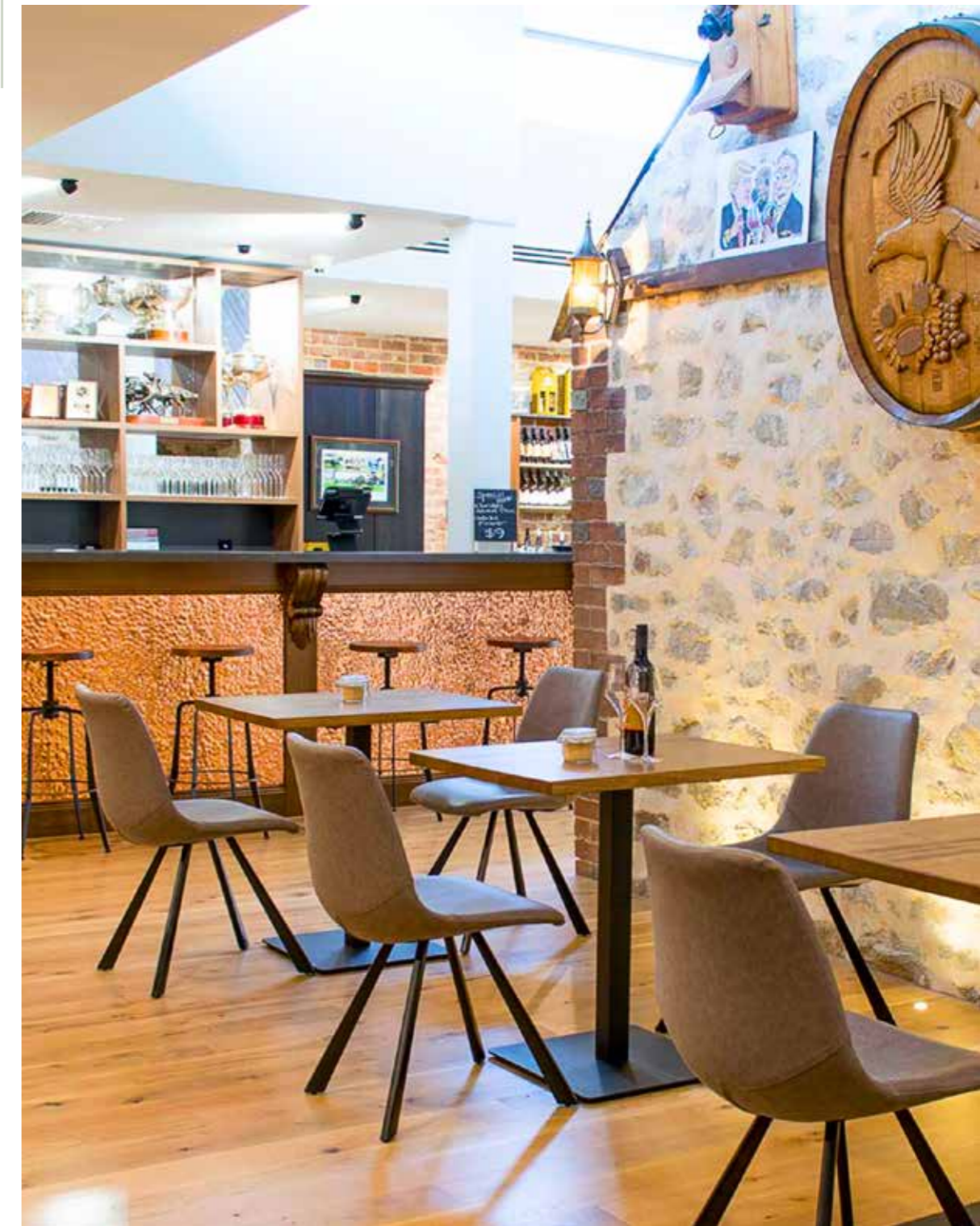

Table components and Coffee tables

Single-column Table, Coffee & Drybar Bases - Disc, Square, Round Square, 4-Way,

Pedestal

Multi-column Table & Drybar Bases - Twin, Frames and A Frames

Table Tops

Chunk Table , Drybar and Coffee Table collection

Welcome to our expansive collection featuring a variety of metal and timber furniture including coffee tables, regular tables, and dry bars. Whether you're furnishing a cozy coffee nook or a bustling restaurant, our range offers an array of shapes, sizes, and configurations to meet your specific needs.

Our tables and dry bars are crafted with options for single or double columns and frames, providing flexibility in design and functionality. Choose from a spectrum of colours and finishes, ensuring each piece complements and enhances your space's aesthetic.

Perfect for both commercial and residential environments, our furniture combines durability with stylish design, promising to elevate any setting with sophistication and practicality.



*Powder
Coating**

**available for metal table and drybar bases not already powdercoated*

Single-Column Table & Drybar Bases

Explore our selection of single column disc, square, and 4-way bases, offering a diverse range of sizes, styles, and finishes tailored to meet your specific needs. Available in both table and dry bar heights, our bases ensure seamless integration into various applications and environments.

With a wide variety of designs featuring multiple customisable features, finding the perfect fit for your space. Whether you're outfitting a restaurant, cafe, or office, our bases provide robust support and enhance the aesthetic appeal of your furniture effortlessly.



Disc

Available in multiple column and disc base sizes and colours

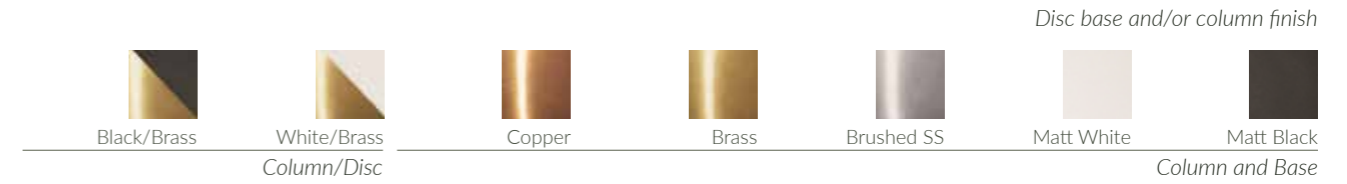

The model presented is for Tables (430 mm), featured in Matt White mild steel disc base (400 mm diameter) and column



The model presented is for Tables (730 mm), featured in Brass stainless steel disc base (540 mm diameter) and Matt Black Mild Steel column



The model presented is for Drybars (1050 mm), featured in stainless steel disc base (450 mm diameter) and column
You can also identify the Table and Drybar disc bases by specific names: **Danube** - Matt Black, **Porto** - Matt White, **Prague** - Stainless Steel, **Rome** - Brass and Copper, **Tivoli** - Mild steel and Stainless combined.

Disc base vs. column height size & colour combinations

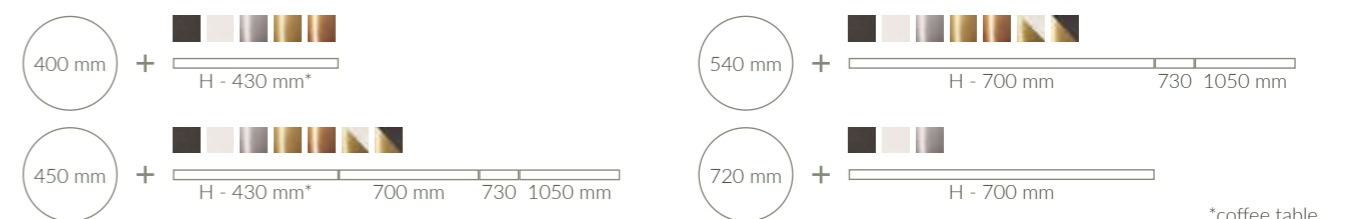

*coffee table

Square

Available in multiple column and square base sizes and colours

Square base and/or column finish



The model presented is for Tables (730 mm), featured in Matt Black mild steel square base (450 mm width) and column



The model presented is for Drybars (1050 mm), featured in Matt Black mild steel square base (450 mm width) and column
You can also identify the Table and Drybar square bases by specific names: **Danube** - Matt Black, **Porto** - Matt White, **Prague** - Stainless Steel

Square base vs. column height size & colour combinations



Round Square

Available in multiple column and round square base sizes and colours

Round square base and/or column finish



The model presented is for Tables (700 mm), featured in Matt White mild steel rounded square base (450 mm width) and column



The model presented is for Drybars (1050 mm), featured in Matt Black mild steel rounded square base (540 mm width) and column
You can also identify the Table and Drybar rounded square bases by a specific name: **Arc**

Round square base vs. column height size & colour combinations



*coffee table

4-Way

Available in multiple column and 4-way base sizes and colours

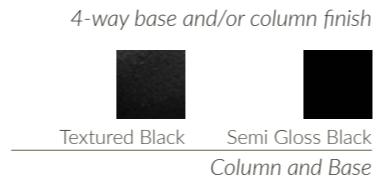

The model presented is **Lisboa** for Tables (730 mm), featured in Semi Gloss Black mild steel 4-way base (500 mm width) and column



The model presented is **Paris** for Drybars (1080 mm), featured in Black Gloss powdercoated cast iron 4-way base



The model presented is **Accra** for Tables (730 mm), featured in the Texturized Black cast iron 4-way base (470 mm width) and column)
You can also identify the Table and Drybar 4-way bases by specific names: **Lisboa** - Semi Gloss Black, **Paris** - Semi Gloss Black and **Accra** - Textured

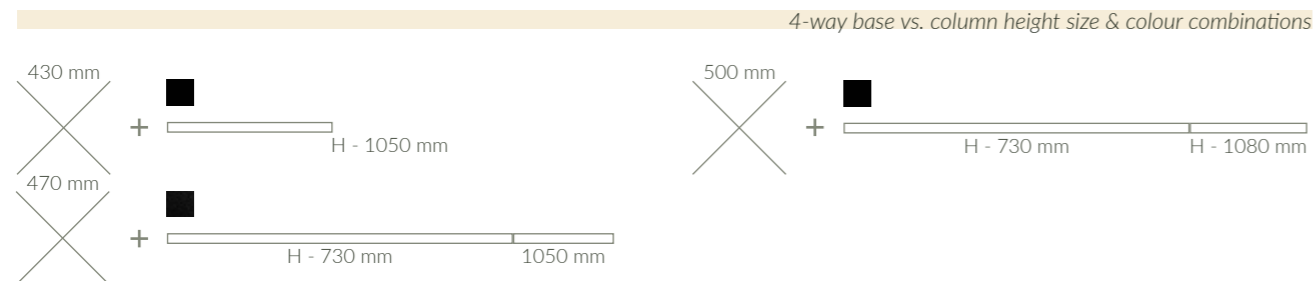

Pisa Table and Coffee Table Base



Pedestal Base

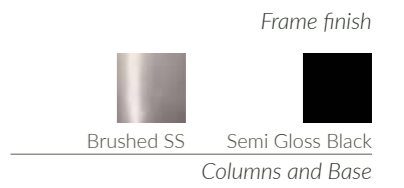

The model presented is for Tables (730 mm) and features the brushed stainless steel pedestal base and column

Twin Table & Drybar Bases

Our comprehensive collection of twin table and dry bar bases are designed for versatility and durability. Available in square, rounded square, sled and castor styles, these bases are crafted in multiple finishes to complement any space.

Perfect for larger table tops our bases offer robust support and stability, ensuring your furniture stands strong in various settings. Whether for restaurants, cafes, or office spaces, these bases provide functional elegance to accommodate your needs.



Square

Available in multiple columns and square base sizes and colours

Square base and/or columns finish



Brushed SS Matt Black
Columns and Base



The model presented is for Tables (730 mm), featured in brushed stainless steel square base (800 x 500 mm) and columns
You can also identify the Table and Drybar square bases by specific names: **Danube** - Matt Black and **Prague** - Brushed SS

Square base vs. columns height size & colour combinations

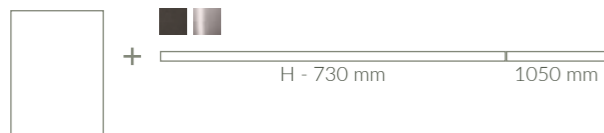

Round Square

Available in multiple columns and round square base sizes and colours

Round square base and/or column finish



Black Brass Matt White Matt Black
Column Columns and Base



The model presented is for Tables (730 mm), featured in Matt Black mild steel rounded square base (800 x 500 mm) and columns
You can also identify the Table rounded square base by specific names: **Arc** - Matt White and Matt Black, **Tivoli** - Black Brass

Sled

Available in multiple columns and twin base sizes and colours

Twin base and/or column finish



Textured Black Semi Gloss Black
Column and Base



The model presented is for Tables (730 mm), features in the Semi Gloss Black mild steel twin base (900 x 700 mm) and columns
You can also identify the Table sled base by specific names: **Lisboa** - Semi Gloss Black

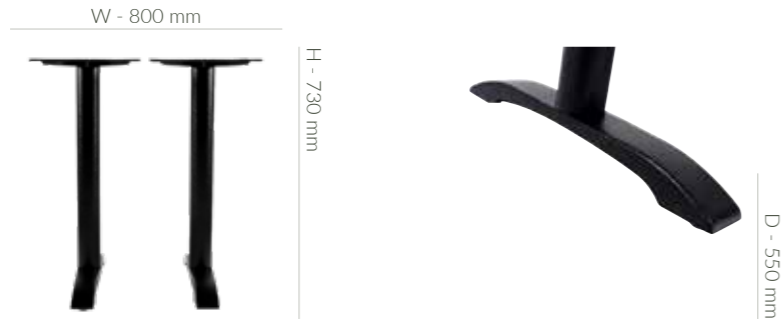

The model presented is for Tables (730 mm) and features a Texturized Black cast iron twin base (800 x 550 mm) and columns
 You can also identify the Table sled bases by specific names: **Accra** - Textured Black

Twin base vs. column height size & colour combinations

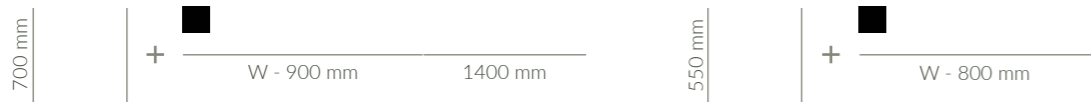

Castor

Available in multiple columns and castor base sizes and colours

Castor base and/or column finish



Matt Black/Brushed SS
Column and Base

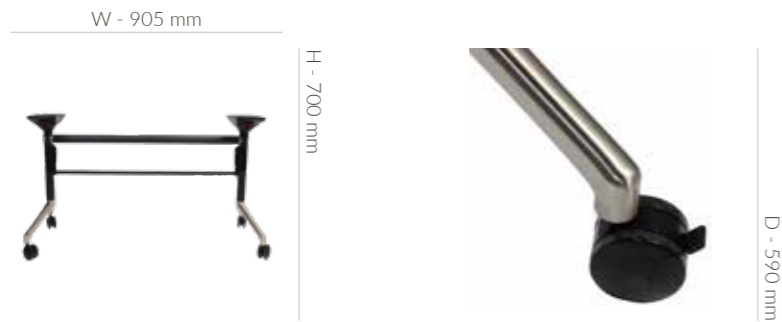

This model is for Tables (700 mm) and features the brushed stainless steel castor base (905 x 590 mm) and Matt Black Aluminum columns
 You can also identify the Table castor base by a specific name: **Manhattan**

Castor base vs. column height size & colour combinations

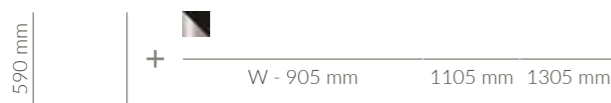

Frame & A-Frame Table & Drybar Bases

Explore our diverse collection of metal and timber coffee table, table, and dry bar frames, meticulously crafted and available in a variety of shapes and sizes. Choose from natural, light oak, walnut, white, and black finishes to suit your space's aesthetic and functional requirements.

Crafted for versatility, our frames are designed to enhance both residential and commercial environments, offering durability and style in equal measure. Whether you're furnishing a cozy lounge area, a bustling restaurant or office, our frames provide the perfect blend of craftsmanship and functionality.



You can add castors to a A-frames



Frames

Frame base and/or column finish



The model presented is for Tables (1200 mm), featured in Black Semi-gloss cast aluminum frame base and column
You can also identify the Table frame base by a specific name: **Barcelona**

Frame base vs. column height size & colour combinations



A-frame base and/or column finish

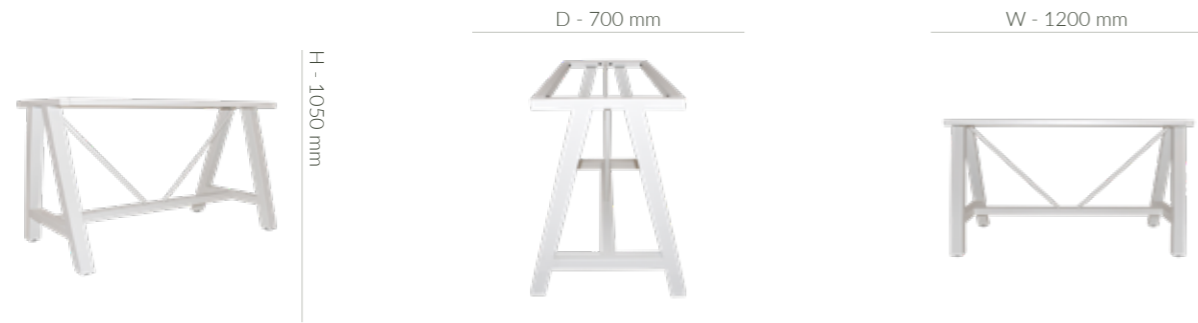

The model presented is for Drybars (1050 mm) and features the Matt White mild steel A-frame base (1200 x 700 mm) and columns

A-frame base vs. column height size & colour combinations

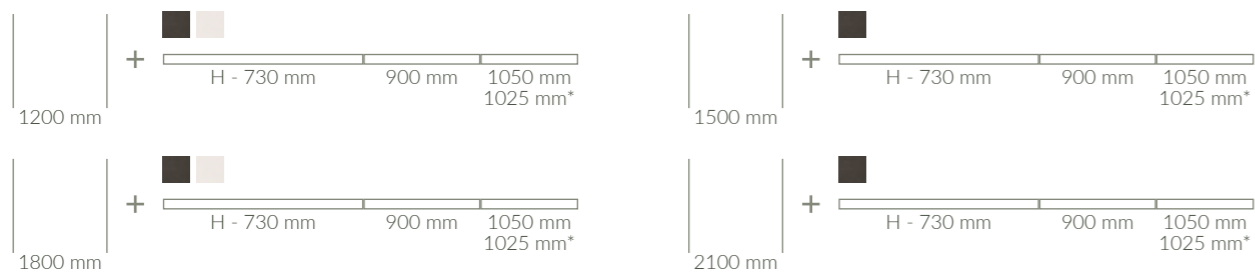

Chunk Table and Coffee Table



Tables

Frame finish



The model presented features the Natural frame from rubberwood, with a base width of 1200 mm

Round Tables



The model presented features the Walnut frame from rubberwood, with a base width of 800 mm

Table Tops

Our extensive collection of rubberwood timber table tops sourced from Vietnam, are available in a variety of elegant finishes including, natural, light oak, light and dark walnut and black.

Choose from a diverse range of shapes and sizes to suit your specific needs and space requirements, whether for a cozy dining nook or a spacious restaurant setting.

Crafted with precision and attention to detail, our rubberwood table tops offer durability and aesthetic appeal, compatible with all our bases and suitable for both residential and commercial use.



Coffee Table



The model presented features the Light Oak frame from rubberwood, with a base width of 700 mm



The models presented feature (from left to right) - Round table top in Natural finish, Square table top in Light Oak finish and Square table top in Walnut finish, all made from rubberwood

Table top size & colour combinations



Chunk

Outdoor Collection

2



Chairs, Stools and Sun Lounges

Doga Side Chair and Stool

Doga Arm Chair

Doga Relax Chair

Bit Chair

Bora Side Chair and Stool

Bora Arm Chair

Trill Side Chair and Stool

Trill Arm

Stack Stool

Net Arm Chair

Net Stool

Net Relax Chair and Bench

Lambretta Chair and Stool

Primavera Chair and Stool

Byron Side

Amalfi Side Chair and Stool

Amalfi Arm

Barbados

Guam

Welcome to our expansive range of outdoor furniture, featuring a diverse selection of chairs, stools, and sun lounges designed to enhance outdoor spaces with both style and durability. Our collection includes options sourced from Nardi Italy, crafted with technopolymer resin, as well as designs from China featuring metal and wicker constructions, available in a wide spectrum of vibrant colours.

Some pieces are designed to accommodate seat pads, providing additional comfort and customization options. Built to withstand the rigours of outdoor commercial environments, ensuring longevity and aesthetic appeal.

Whether you're furnishing a bustling patio, serene terrace, or relaxing poolside area, our outdoor furniture collection offers the perfect blend of functionality and aesthetic charm, transforming any outdoor setting into a welcoming retreat.



Outdoor Suitable

Powder Coating Available*

*available for metal chairs: Lambretta, Primavera, Byron, Amalfi

Doga Side

The Doga outdoor side chair and stool, crafted to enhance your outdoor seating with its sleek, slim slatted design and available in a range of unique colours. This chair and stool promote airflow and blend seamlessly into any outdoor environment.

The "Doga" range also comprises an armchair and relax lounge chair version for enhanced comfort. It is ideal for gardens, patios, or outdoor dining areas, combining durability with stylish design, making it a perfect choice for both residential and commercial outdoor spaces.

NARDI



Polypropylene Chair

Chair frame finish



Capuccino

Pera

Menta

White

Anthracite

Agave



The model presented features the Pera finish

Polypropylene H745 Stool



The model presented features the Anthracite finish

Polypropylene Chair

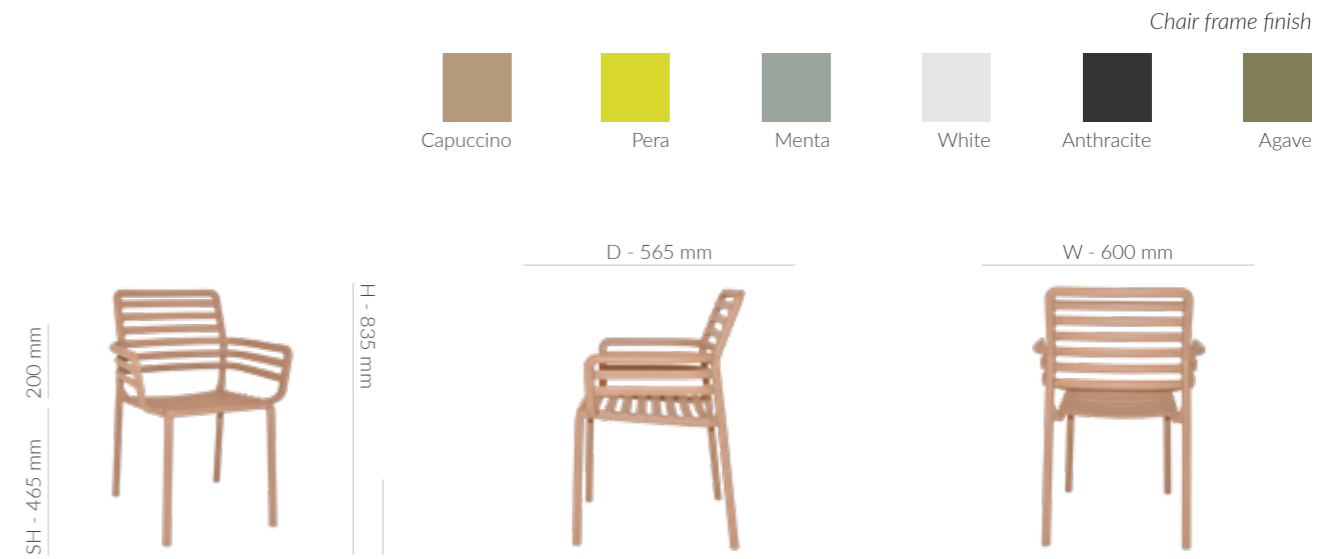

The model presented features the Capuccino finish

Doga Arm

The Doga outdoor arm chair, meticulously designed to elevate your outdoor seating experience with its slatted design and variety of colours. This chair not only enhances airflow but also seamlessly integrates into any outdoor setting. The Doga range includes a side chair and stool, offering versatile seating options, along with the Relax version, which provides enhanced comfort for diverse seating arrangements.

Perfect for gardens, patios, or outdoor dining areas, the Doga Arm blends durability with stylish design, making it an ideal choice for both residential and commercial environments alike.

NARDI

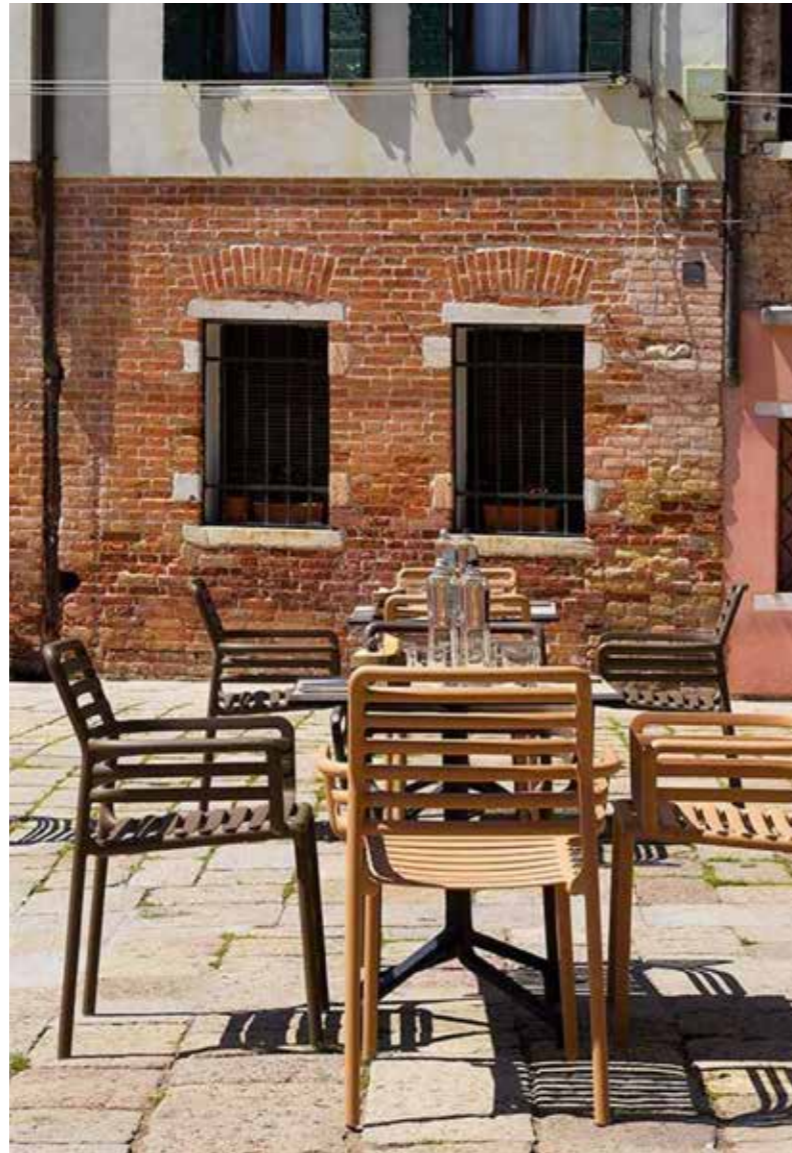

Doga Relax

The Doga Relax chair is a lounge-style armchair ideal for creating a relaxed outdoor atmosphere. Alongside it, the Doga range offers armchairs, side chairs, and stools, providing diverse seating options.

Available in a variety of colours, these pieces feature a slatted design that enhances their aesthetic appeal and airflow, making them perfect for both residential and commercial outdoor settings.

NARDI



Polypropylene Chair



The model presented features the Agave finish

Bit

The Bit chair, crafted by Nardi Italy, designed to withstand outdoor conditions with its perforated seat and back design that allows for quick drying is available in a variety of colours. This chair blends functionality with contemporary style, making it ideal for outdoor environments.

Perfect for enhancing outdoor dining areas, patios, and gardens, the Bit Chair combines durability and comfort, ensuring lasting performance and aesthetic appeal in any setting.

NARDI



Polypropylene Chair

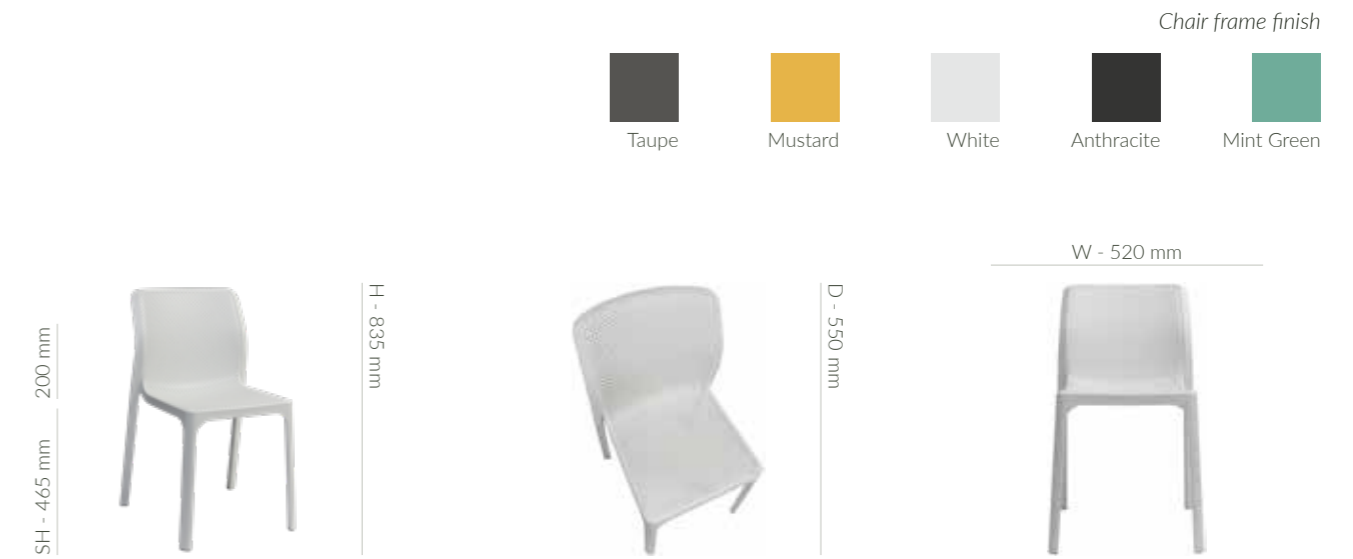

The model presented features the White finish

Bora Side

The Bora side chair and stool from Nardi, Italy, are crafted from durable fiberglass resin and feature a sleek design. Their continuous tubular structure and rounded profile offer a modern aesthetic. The seat and back form a seamless single piece, providing exceptional comfort with shapes that complement the overall design.

Combining style and practicality, the Bora side chair and stool make versatile additions to any space. Also available in an armchair version and a variety of colours, they are perfect for both indoor and outdoor settings.

NARDI



Polypropylene Chair

Chair frame finish



The model presented features the Celeste Blue finish

Polypropylene H750 Stool

Chair frame finish



The model presented features the Agave finish

Polypropylene H650 Stool

Chair frame finish



The model presented features the Anthracite finish

Bora Arm

The Bora arm chair from Nardi, Italy, combined with the side chair and stool are crafted from durable fiberglass resin and feature a sleek design. Their continuous tubular structure and rounded profile offer a modern aesthetic. The seat and back form a seamless single piece, providing exceptional comfort with shapes that complement the overall design.

Combining style and practicality, the Bora arm chair make a timeless addition to any space. Also available in an array of colours, they are perfect for both indoor and outdoor environments.

NARDI

Bora Side



Polypropylene Chair

Chair frame finish



D - 590 mm

W - 585 mm



The model presented features the Celeste Blue finish

Polypropylene Chair

Chair frame finish

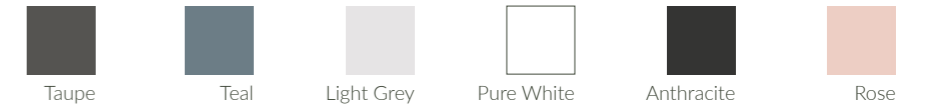

D - 515 mm

W - 500 mm



The model presented features the Teal finish

Trill collection ensemble

Trill Side

The Trill Side chair and stool, crafted from durable fiberglass resin from Nardi, Italy and featuring a harmoniously sculptural, timeless design. Available in a variety of colours, these pieces add elegance and functionality to any space.

The Trill collection also includes an armchair version, offering even more versatility and comfort for your seating arrangements. Perfect for both indoor and outdoor environments, the Trill Side chair and stool are designed to enhance any setting with their stylish and enduring appeal.

NARDI



Trill Side

Polypropylene H760 Stool

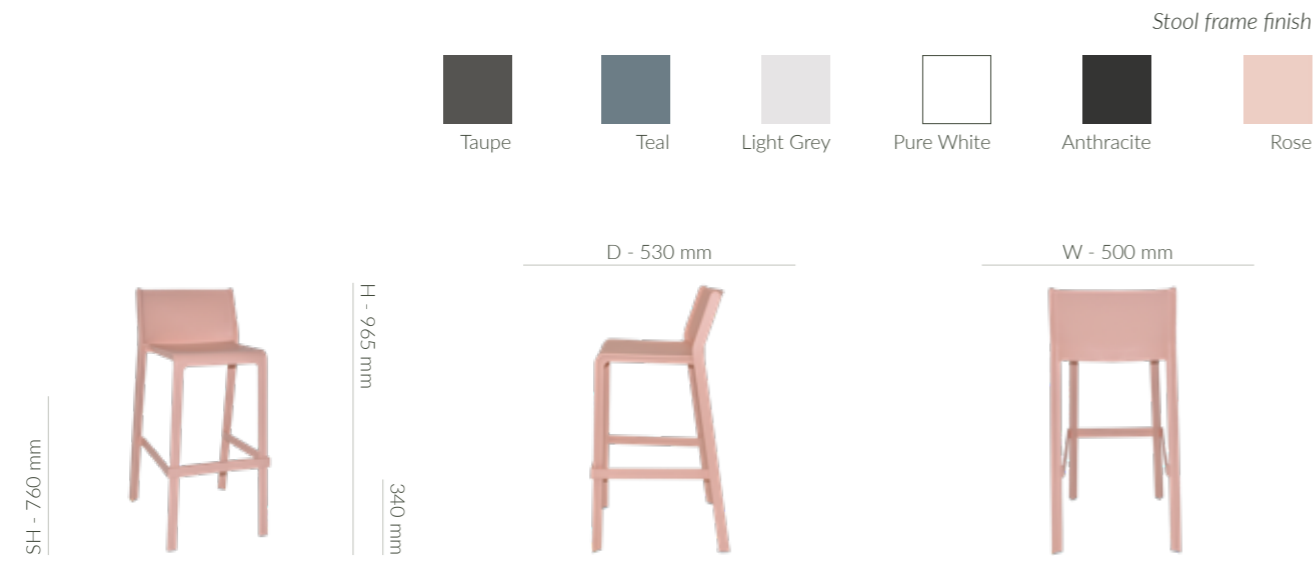

The model presented features the Rose finish

Trill Arm

The Trill Arm chair, crafted from durable fiberglass resin and showcasing a harmoniously sculptural, timeless design. Available in a variety of colours, this chair adds elegance and functionality to any space.

The Trill collection also includes a side chair and stool, offering a complete range of versatile seating options. Perfect for both indoor and outdoor environments, the Trill Arm chair is designed to enhance any setting with its stylish and enduring appeal.

NARDI



Polypropylene Chair



The model presented features the Taupe finish

Stack

The Stack mini and maxi stool, crafted from durable fiberglass resin in a full injection mold. Available in anthracite or white, this stool adds a rustic and earthy feel to the environment.

The matching tables are available through indent. Perfect for both indoor and outdoor hospitality environments,

NARDI



Maxi and Mini Stool

Chair frame finish



The models presented feature the Maxi stool in White and the Mini stool in Anthracite

Net Arm

The Net chair, also available in a relax lounge style chair crafted by Nardi Italy, is designed to withstand outdoor conditions with its single-body fibreglass resin build and decorated radial pattern of square perforations across the whole surface.

The design allows for quick drying and is available in a variety of colours. This chair blends functionality with contemporary style, making it ideal for outdoor environments.

Pad fabrics and colours



NARDI



Chair frame finish



The model presented features the Mint Green finish

Polypropylene H650 Stool

Stool frame finish



The model presented features the White finish

Net Arm

Polypropylene H760 Stool

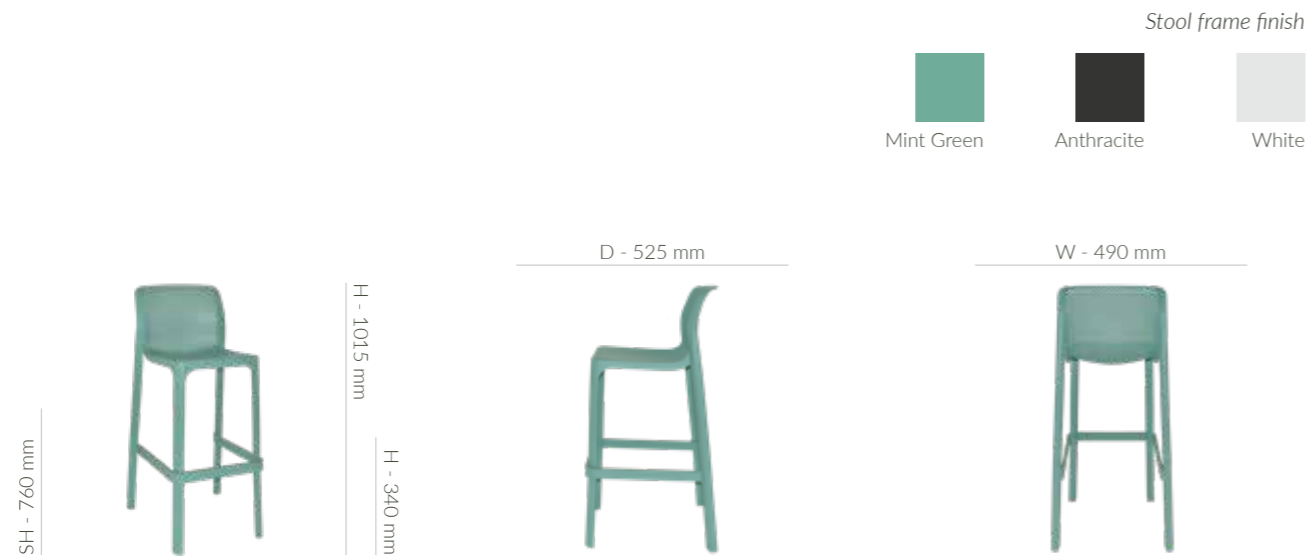

The model presented features the Mint Green finish

Net Relax

The Net Relax chair, crafted by Nardi Italy and also available as a standard armchair, is built to endure outdoor conditions with its single-body fiberglass resin construction.

Featuring a stylish radial pattern of square perforations across the entire surface, this design allows for quick drying. Available in a variety of colours, the Net Relax Chair seamlessly combines functionality with contemporary style, making it perfect for any outdoor setting.

Pad fabrics and colours



NARDI



Polypropylene Chair



The model presented features the Anthracite finish

Polypropylene Bench



The model presented features the White finish

Net Relax

Lambretta

The Lambretta outdoor aluminium chair and stool range, designed for both durability and style. Available in anthracite, white, or a raw finish that can be custom powder-coated to your preference, these pieces offer flexibility to match any outdoor decor

Featuring reinforced welds for enhanced strength and longevity, the Lambretta range is also stackable up to four high for easy storage and space-saving solutions.



Metal Chair

Chair frame finish



Aluminum



The model presented features the Raw finish, from aluminum

Metal H750 Stool

Stool frame finish



Aluminum



The model presented features the Anthracite finish, from aluminum

Primavera

the Primavera outdoor aluminium chair and stool range, available in sophisticated anthracite or classic white. Featuring a stylish slatted design and reinforced welds for enhanced durability, these pieces are built to withstand outdoor conditions. The Primavera range is stackable up to four high, making it ideal for convenient storage and space-saving solutions, perfect for any outdoor setting.



Metal Chair



The model presented features the Anthracite finish, from aluminum

Metal H743 Stool

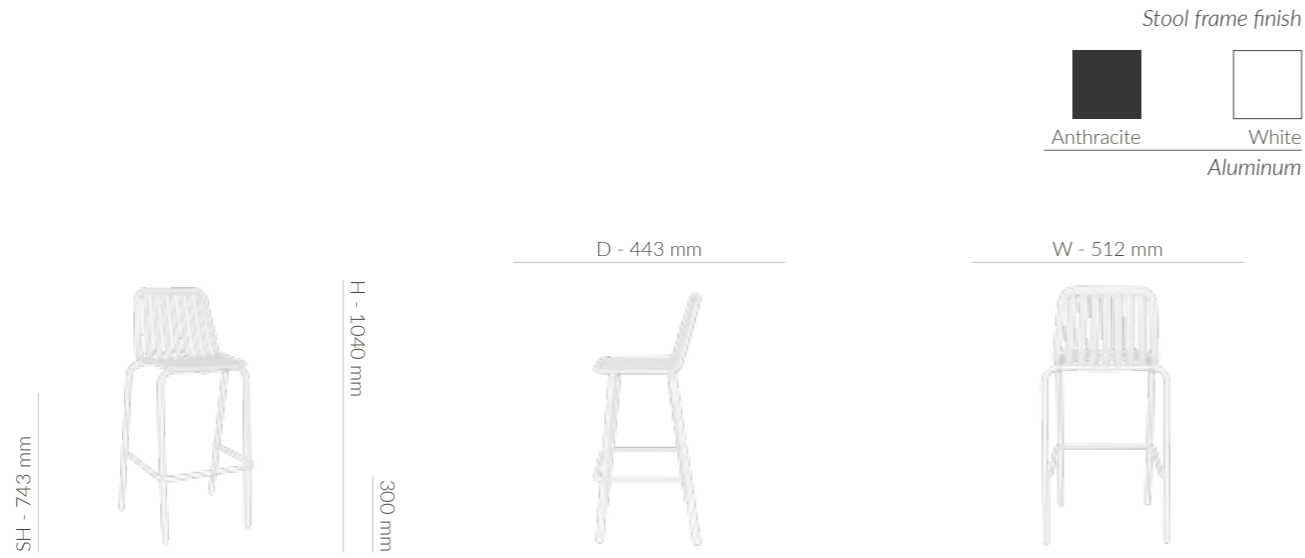

The model presented features the White finish, from aluminum

Byron Side

The Byron range, an aluminum outdoor chair and stool collection, designed to enhance any outdoor setting with elegance and durability. Available in sleek Black, pristine White, or calming Sage Green, each piece is crafted with a highly durable powder coat for weather resistance and a modern matte finish. Reinforced welds ensure robust stability, while their stackable design allows for convenient storage.

Imported from China and backed by a 12-month warranty, these chairs and stools are perfect for cafes, restaurants, or residential patios, blending practicality with sophisticated aesthetics.



Metal Chair

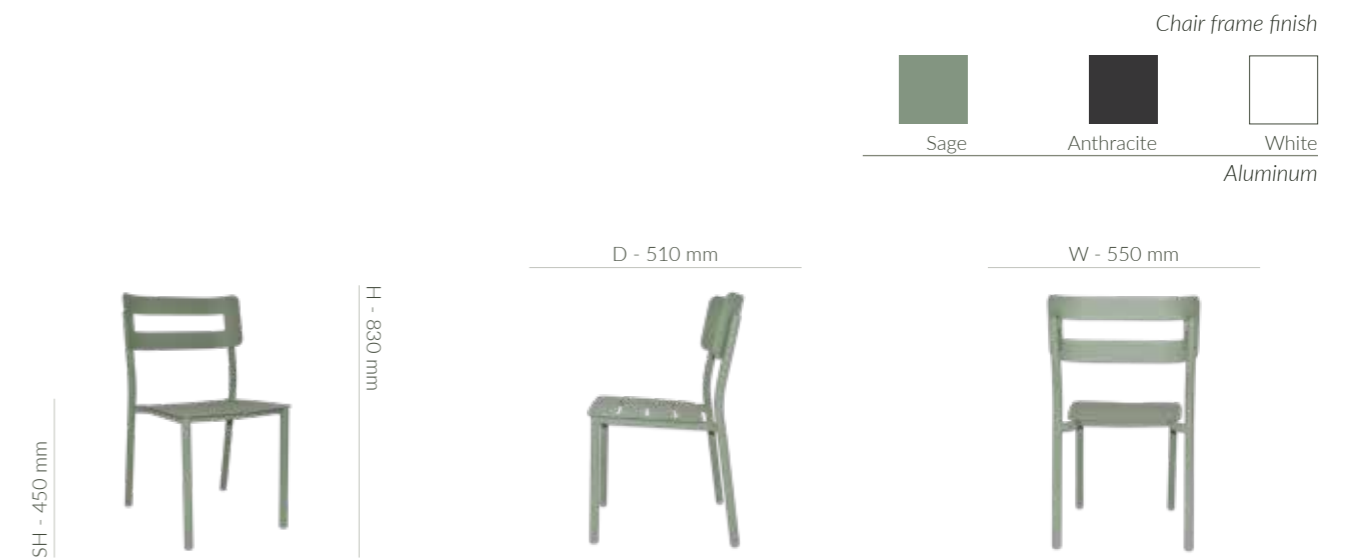

The model presented features the Sage finish, from aluminum

Metal H750 Stool



The model presented features the Anthracite finish, from aluminum

Amalfi Side

The Amalfi wicker chair and stool range, also available in an armchair version. Featuring a metal frame painted to resemble bamboo, this collection offers a charming blend of durability and style.

The Amalfi range comes in three elegant colour combinations: black and white, grey and white, and blue and white (side chair only). These pieces are stackable up to six high, making them ideal for easy storage and space efficiency. Perfect for adding a touch of sophistication to any outdoor setting



Amalfi Side

Metal Chair



The model presented features the Black/White finish from synthetic wicker, frame is made from aluminum

Metal H760 Stool



The model presented features the Grey/White finish made from synthetic wicker, frame is made from aluminum

Amalfi Arm

The Amalfi Armchair features a metal frame painted to mimic the natural look of bamboo, adding a touch of elegance to any space. Available in two stylish colour combinations - black and white, and grey and white - these chairs and stools are designed to blend seamlessly with various decor styles.

For added convenience, all pieces in this range are stackable up to four high, making them easy to store and perfect for both residential and commercial settings.



NARDI

Barbados

The Barbados Sunlounge from Nardi, Italy, was designed for ultimate relaxation. Featuring armrests and a tubular resin frame, this sunlounge is complemented by breathable synthetic fabric for optimal comfort. The backrest adjusts to four different positions, allowing you to find the perfect angle for lounging.

Available in various frame and fabric colour combinations, including blue and white or taupe and white. Additionally, this sunlounge is stackable for convenient storage, making it an ideal choice for both residential and commercial outdoor settings.



Metal Chair

Chair back and seat finish



Grey/White Black/White
Synthetic Wicker

D - 610 mm

W - 590 mm



The model presented features the Grey/White finish made from synthetic wicker, frame is made from aluminum

Polypropylene Sun Lounge

Sun lounge frame finish



Blue Taupe White
Back and seat Frame

L - 1950 mm

W - 710 mm



The model presented features the Blue fabric finish

NARDI

Guam

The Guam Sunlounge from Nardi Italy, designed for superior comfort and functionality. Crafted with durable resin, this sunlounge features armrests and a backrest that can be adjusted to four different positions.

For easy storage, the Guam Sunlounge is stackable. It also includes non-slip feet and wheels for added stability and mobility, making it a perfect addition to any outdoor setting.



Cube table



Polypropylene Sun Lounge

Sun lounge frame finish



White

L - 1950 mm

W - 710 mm

SH - 300 mm



H - 850 mm



The model presented features the White finish

Tables and Coffee Tables

Cube Table

Step Table and Coffee Table

Clip X Table

Cube Bar Table

Doga Coffee Table

Pop Coffee Table

Net Coffee Table

Discover our collection of technopolymer resin and aluminium tables from Nardi Italy, designed to complement the chairs in the collection with a simple and linear aesthetic.

Crafted from technopolymer resin and aluminium, these tables are available in multiple colours to suit various décor themes. They feature non-slip feet for stability and are enhanced with UV-resistant additives for outdoor durability. Available in multiple sizes and shapes, they offer versatile solutions for both indoor and outdoor settings.

Ideal for residential and commercial use, these tables seamlessly match with the chairs from the collection, creating cohesive and stylish dining or lounge areas.

Step table



Cube Table and Drybar

The Cube table, a solid and minimalist professional table crafted from resin with a DurelTop surface. This innovative tabletop system is engineered to offer exceptional practicality, durability, and elegance. It features an aluminium structure that enhances its solidity and sturdiness, complemented by square-base legs in lacquered aluminium.

Available in two sizes (1400 x 800 and 800 x 800) and two sophisticated colours (Anthracite and White), the Cube Table is designed to meet the highest standards of functionality and aesthetic appeal. It can also be equipped with a leg extension to adjust its height to drybar height, offering versatility for various settings. Ideal for professional environments seeking a blend of modern design and robust durability.

NARDI

Frame material



Powdercoated Aluminum

Top material



Polypropylene



Tables 800-1400 x 800

Frame finish

Anthracite Taupe White

Top and legs



The model presented features the White powdercoated aluminum frame and a White fiberglass polypropylene top, with a width of 800 mm

Drybars 800-1400 x 800

Frame finish

Anthracite Taupe White

Top and legs



The model presented features the Anthracite powdercoated aluminum frame and an Anthracite fiberglass polypropylene top

Step Table and Coffee Table

The Step Table, crafted from fiberglass with a round box top characterized by small decorative perforations that also function as effective drainage. This table features a stable base with three legs, designed for easy assembly and disassembly.

The Step Table includes a kit to set it up at two heights, offering versatility for different settings. Available colours include Anthracite, Taupe, and White. Ideal for outdoor environments, this table combines modern design with practical functionality.

NARDI

Frame and top materials



Polypropylene



Table

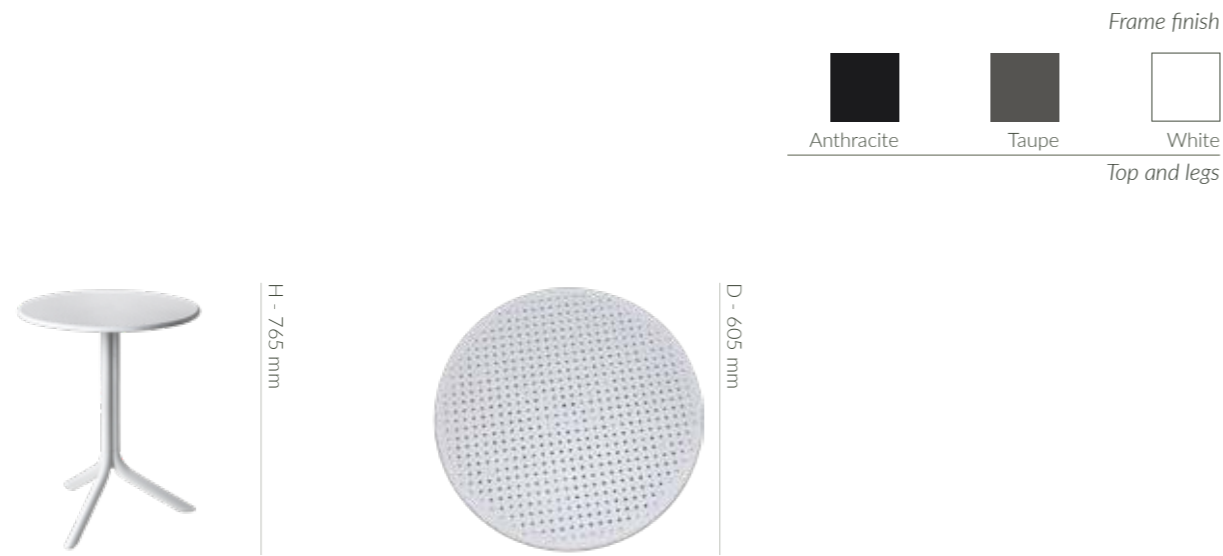

The model presented features the White fiberglass polypropylene top and frame

NARDI

Clip X Table

The Clip X Table, available in anthracite was designed to maximize space efficiency without compromising on style or functionality. Crafted from fiberglass resin, this professional square table features a central support with four spokes for stability. The tabletop is made of DurelTop, photo-engraved with a diamond perforated pattern, adding a touch of elegance to its design.

Ideal for compact settings, the Clip X Table is perfect for both indoor and outdoor environments where space optimization is key.

Frame and top materials

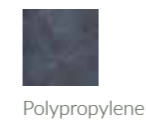

Coffee Table



The model presented features the White fiberglass polypropylene top and frame

Table



The model presented features the Anthracite fiberglass polypropylene top and frame

Doga Coffee Table

The Doga Coffee Table, crafted from lightweight fiberglass resin with a contemporary slatted design. This monobloc low table features a round top, making it easy to move and stackable for convenient storage. It is designed to be easily sanitized and entirely recyclable, ensuring both practicality and sustainability.

Ideal for both indoor and outdoor use and complimenting the Doga chair range, the Coffee Table adds a modern aesthetic to any environment while providing functionality and ease of maintenance.

NARDI

Frame and top materials



Polypropylene



NARDI

Net Coffee Table

the Net Coffee Table, crafted from fiberglass resin with a rectangular top adorned with the perforated pattern. This table features non-slip feet for stability and is available in Anthracite or White. Ideal for both indoor and outdoor settings, the Net table combines sophisticated design with practical functionality. Its durable construction and stylish perforated pattern make it a versatile addition to any space, suitable for residential and commercial use.

Frame and top materials



Polypropylene



Coffee Table

Frame finish



Anthracite

W - 500 mm



H - 395 mm

The model presented features the Anthracite fiberglass polypropylene top and frame

Coffee Table

Frame finish



Anthracite



White

Top and legs

W - 1000 mm



H - 400 mm



H - 580 mm

The model presented features the Anthracite fiberglass polypropylene top and frame

NARDI

Pop Coffee Table

The Pop Coffee Table, crafted from fiberglass resin with a unique and multifunctional design. This eye-catching piece features rigorous lines and gently rounded shapes, ensuring there are no sharp edges on any component.

Pop surprises with a pull-out surface under its top that transforms into a practical tray, adding versatility to its modern aesthetic. Ideal for both residential and commercial spaces, the Pop Coffee Table combines functionality with innovative design, making it a stylish addition to any environment.



Bologna drybar base



Coffee Table

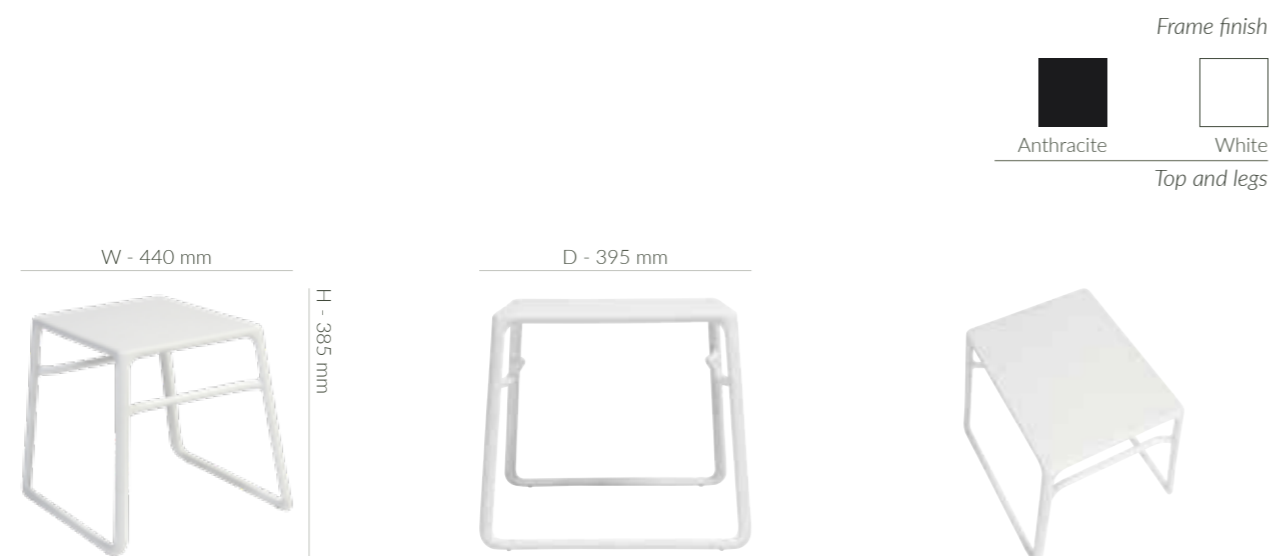

The model presented features the White top and frame

Table and Drybar Bases

Single-column Table and Drybar bases - 4-Way, Disc

Multi-column Table and Drybar bases - Twin

Table Tops

Discover our versatile collection of outdoor table and drybar bases, available in Anthracite or White finishes. Choose from a variety of shapes and sizes, including disc, 4-way, and twin bases, all designed to complement your outdoor space.

Compatible with the Alto outdoor top range, these bases ensure seamless integration and functionality, making them ideal for creating stylish and functional outdoor dining or lounging areas. Perfect for both residential and commercial use, they offer sturdy support and durability in any outdoor environment.

Moon table base



Single-Column Table & Drybar Bases

Discover our extensive selection of outdoor single column disc, and 4-way bases, meticulously crafted to cater to a wide range of preferences in size, style, and finish. Whether you need a sleek and modern design or a more traditional look, our bases are designed to meet your specific needs with precision.

Available in both table and dry bar heights, our bases are versatile and adaptable, seamlessly integrating into various settings from bustling restaurants to laid-back cafes and dynamic office spaces. Each base is engineered for durability and stability, ensuring reliable support for your furniture.



Congo single-column table base

4-Way

Available in multiple column and 4-way base sizes and colours

4-way base and/or column finish



The model presented is Congo for Tables (730 mm) or Drybars (1050 mm), featured in White galvanised cast iron 4-way base and column



The model presented is Kobe for Tables (720 mm) or Drybars (1080 mm), featured in Anthracite powdercoated aluminum 4-way base and column



The model presented is Nara for Tables (720 mm) or Drybars (1080 mm), featured in Anthracite powdercoated aluminum 4-way base and column

4-Way

Available in multiple column and 4-way base sizes and colours

4-way base and/or column finish



The model presented is Calice for Tables (720 mm) or for Drybars (1070 mm), featured in Anthracite aluminum 4-way base and column

4-way base vs. column height size & colour combinations

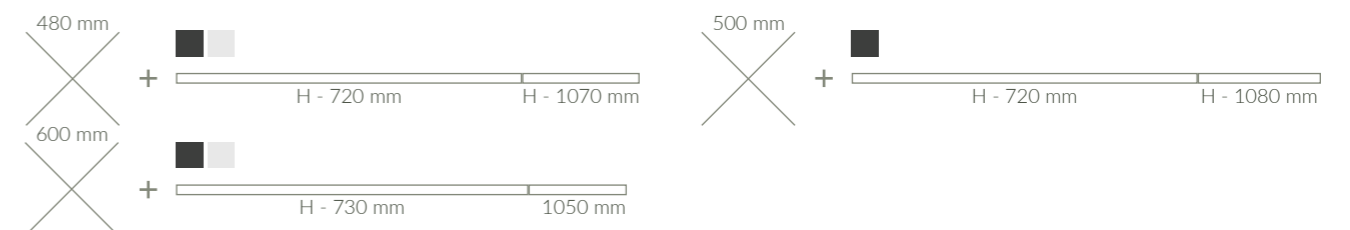

4-Way

Available in multiple column and 4-way base sizes and colours

4-way base and/or column finish



The model presented is **Bologna for Tables (715 mm)**, featured in White galvanised cast iron 4-way base and column

4-way base vs. column height size & colour combinations



Disc

Available in multiple column and disc base sizes and colours

Disc base and/or column finish



The model presented is **Moon for Tables (730 mm)** or **Drybars (1050 mm)**, featured in Anthracite galvanised cast iron disc base and Anthracite zinc coated steel column

Disc base vs. column height size & colour combinations

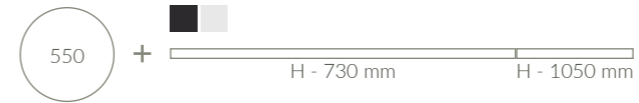

Twin Table & Drybar Bases

Explore our collection of outdoor twin table bases, meticulously designed for versatility and durability. Available in standard or folding styles, these bases come in multiple finishes, including black or white, to seamlessly complement any outdoor space.

Ideal for accommodating larger tabletops, our bases provide robust support and stability, ensuring your furniture stands strong in various settings. Whether furnishing restaurants, cafes, or office spaces, these bases blend functional elegance with durability to meet your specific needs.



Two-Way

Twin base and/or column finish



Anthracite



The model presented Nara is for Tables (720 mm) and features the Anthracite powdercoated aluminum twin base and columns
You can also identify the Table twin base by two specific names: **Nara - folding base** and **Kobe - fixed base**

Twin base and/or column finish



Black Semi-gloss



The model presented is for Tables (720 mm), featured in Black Semi-gloss cast aluminum twin base and column
You can also identify the Table twin base by a specific name: **Bologna**

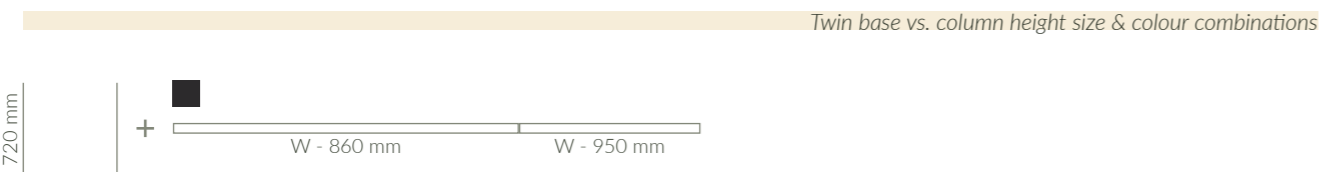

Table Tops

Enhance your outdoor space with our matt anthracite Aluminium slatted table tops, designed for both durability and style. Available in round, square, or rectangle shapes, these table tops offer versatility to suit various outdoor settings.

Crafted from high-quality Aluminium, these slatted table tops are built to withstand outdoor elements while maintaining a sleek and modern appearance. The matt anthracite finish adds a contemporary touch, blending seamlessly with any outdoor decor.

Perfect for cafes, restaurants, or residential patios, these table tops combine practicality with aesthetic appeal, providing a sturdy surface for dining and entertaining outdoors. Choose the shape that best fits your space and enjoy long-lasting durability with our Aluminium slatted table tops.



Table top finish



Anthracite

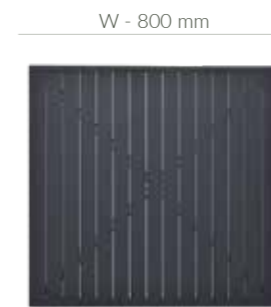
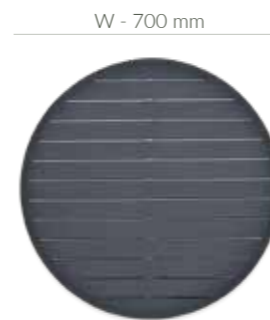

The models presented feature - Round table top in Anthracite finish, Square table top also in Anthracite finish, both from aluminum

Table top size & colour combinations

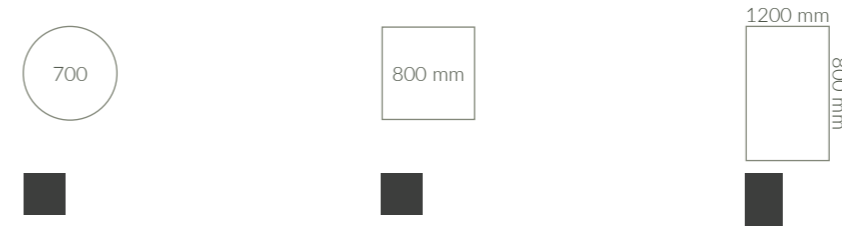

Gaming Collection

3



Congo table bases



Seats and Pedestals

Cairo

Luxor

Macau

Trump

Introducing our gaming stool collection, featuring four distinct designs with interchangeable bases. Built for comfort and durability, these sturdy stools include a heavy-duty non-return swivel mechanism. Available in standard vinyl black, they can also be custom upholstered for indent project orders.

With the exception of the Macau model, each stool includes a convenient handle for easy mobility and use. Our latest addition, the Trump model, stands out as the only gaming stool in our range equipped with armrests, adding to its appeal and functionality.

Cairo

The Cairo gaming stool, designed for both style and functionality. Featuring an angular oval-shaped backrest, this stool is available in sleek all black or a striking combination of black with a polished stainless steel disc base. Alternatively, opt for the stability of a black 4-leg base.

Equipped with a convenient handle integrated into the backrest, the Cairo stool offers ease of mobility and use. Whether enhancing a gaming setup or adding flair to a modern interior, the Cairo gaming stool blends contemporary design with practicality for a versatile seating solution.

Shell fabrics and colours

Vinyl



Black



Luxor

The Luxor gaming stool, where comfort meets contemporary design. Highlighted by its distinctive croissant-shaped backrest, choose between three stylish options: a sleek all-black finish for a minimalist look, or a sophisticated black base paired with polished stainless steel disc accents or the modern allure of a black 4-leg base. All options are equipped with a convenient handle integrated into the backrest, allowing for easy maneuverability and adjustment. Ideal for gaming setups or modern interiors, the Luxor gaming stool combines ergonomic support with aesthetic appeal.

Shell fabrics and colours

Vinyl



Black



Metal Stools

Leg frame type



Pedestal Disc

Leg frame finish



Black/Stainless Steel Black

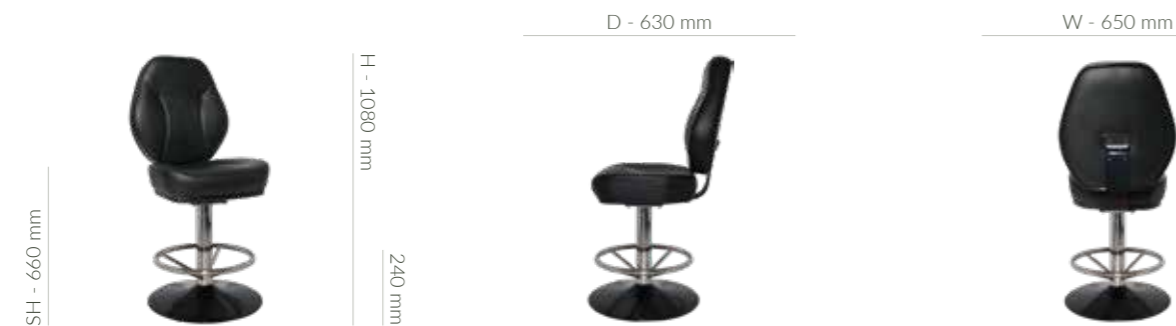

The model presented features the Disc leg frames in Polished Stainless Steel, Vinyl shell fabric, the Black colour

Metal Stools

Leg frame type



Pedestal Disc

Leg frame finish



Black/Stainless Steel Black

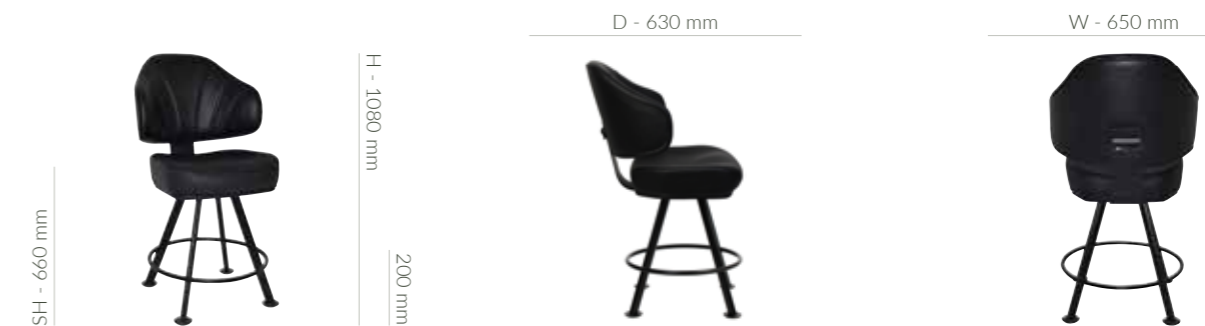

The model presented features the Pedestal frame in Black Mild Steel, Vinyl shell fabric, the Black colour

Macau

The Macau gaming stool, designed with ergonomic excellence and modern aesthetics in mind. Its distinctive half-moon shaped backrest offers superior comfort and support during extended gaming sessions or casual use. Available in two stylish configurations, you can choose between an all-black disc or 4 leg base finish for a sleek and minimalist look, or opt for a black disc base complemented by polished stainless steel accents to add a touch of sophistication. All options include a practical handle integrated into the backrest, ensuring easy mobility and adjustment to suit your seating preferences.

Shell fabrics and colours

Vinyl



Black



Trump

The Trump gaming stool, the pinnacle of comfort and style in gaming furniture. Designed with ergonomic armrests and a rounded square-shaped tub design, the Trump stool ensures unparalleled support during intense gaming sessions or leisurely use.

Available exclusively with a handle integrated into the backrest for effortless maneuverability, the Trump stool is offered in two elegant options: a sleek all-black finish for a modern aesthetic, or a sophisticated brushed brass disc base to elevate any gaming or living space. Ideal for both functionality and aesthetics, the Trump gaming stool combines ergonomic design with premium materials, making it a standout choice for discerning gamers and enthusiasts alike.

Shell fabrics and colours

Vinyl



Black



Metal Stools

Leg frame type



Pedestal

Disc

Leg frame finish



Black/Stainless Steel

Black

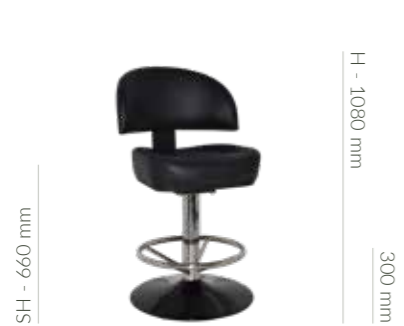

D - 630 mm



W - 650 mm



The model presented features the Disc leg frames in Polished Stainless Steel, Vinyl shell fabric, the Black colour

Metal Stools

Leg frame type



Disc

Leg frame finish



Brass

Black



D - 650 mm



W - 630 mm



The model presented is featured in a Brass frame, Vinyl shell fabric, the Black colour

Bespoke Collection

4



Fabrics

Warwick fabrics is one of the world's leading fabric and textile wholesalers providing premium quality materials to industry specialists since 1966.

This is why we have built a strong relationship with them to supply all fabric for our upholstered products.

These fabrics include Gravity, Pelle, Benito, Eastwood and Regis. This partnership allows us the opportunity for cheaper list rates as well as the ability for us to order fabric for you for your next custom upholstery project.



Coatings

We offer a large range of both Dulux and Interpon colour ranges producing high quality outcomes. The lead time on powder coating is usually 7 - 14 days depending on the quantity ordered.

Our standard pricing is based on stocked colours listed in the resources document. If your colour isn't in the document, check with us as sometimes we can access other powders, however prices will differ.





Disclaimer

The information contained in this catalogue is to be used only as a guide to assist with product selection. We make no representation or warranty as to the completeness or accuracy of the information contained herein.

The products and specifications set forth in this catalogue are subject to change without notice and we disclaim any and all liability for such changes. The information contained herein is provided without warranties of any kind, either expressed or implied, and we disclaim any and all liability for typographical, printing, or production errors or changes affecting the products and/or the specifications contained herein.

Product specifications should be confirmed before ordering.



Convenient
Commercial Furniture